

# TECHNICAL MANUAL



# Dolphin pro HD+

## Battery charger

**pro HD+ 24V40A**  
399165 - PF.14035\_40A

**pro HD+ 24V60A**  
399175 - PF.14035\_60A

**pro HD+ 24V100A**  
399185 - PF.14036

# SAFETY PRECAUTIONS

NOT-DOLPROHD-03



**TO PREVENT ANY RISK OF ELECTRIC SHOCK OR FIRE, READ THIS MANUAL CAREFULLY BEFORE INSTALLING THE EQUIPMENT.**

In the event of any problems or misunderstandings, please contact your dealer.

This equipment is not designed for use by people (including children) with diminished physical, sensorial or mental capacities, or people without experience or knowledge of such equipment, unless they have received prior instruction in the use of the equipment from a person responsible for their safety or are under the supervision of such a person. Ensure that children are supervised in order to prevent them playing with the device.

This equipment contains components that may cause electric arcs or sparks, when connecting cables, for example. To prevent any risk of fire or explosion, do not install this equipment close to flammable materials, liquids or gases.



## **Installation precautions**

To prevent any risk of irreversible damage to the equipment, ensure that you comply scrupulously with the following recommendations.

- ▶ This device must not be installed close to a heat source.
- ▶ It must not be installed in an airtight or badly-ventilated compartment.
- ▶ The ventilation inlets must not be obstructed.
- ▶ Clearance of at least 10 cm must be allowed around the housing to guarantee adequate convection.

NOT-DOLPROHD-03

- ▶ This device must not be exposed to running water, water spray and dust of any kind.
- ▶ We recommend securing the device in a vertical position, with the cable outlet pointing downwards.
- ▶ You are formally prohibited from making mechanical alterations to the housing, including making additional holes, for example.
- ▶ Under no circumstances should this device be seen as a toy. It should therefore, quite clearly, not be left in the hands of a child.



## **Connection precautions.**

To prevent any risk of electric shock or irreversible damage to the equipment, you should comply strictly with the following recommendations.

- ▶ The installation to which this device is connected must comply with the applicable regulations.
- ▶ This device is designed to be connected to 220-240V 50Hz or 100-120V 60Hz single phase circuits. 115V / 230V selection is automatic. (220-240V only for 24V100A version)
- ▶ The mains power line must feature a cut-off device with differential protection, to protect individuals against electric shocks. Refer to the device's electricity consumption characteristics to select the size and type of circuit breaker.
- ▶ Prior to commencing connection, the mains cable gland in the packaging must be assembled and correctly attached to the housing (using the nut provided), in the hole designed for this purpose.
- ▶ For safety reasons, the device's EARTH terminal (PE "Protective Earth" terminal), must be connected to the system's physical earth (yellow &

# SAFETY PRECAUTIONS

NOT-DOLPROHD-03

green wire of the mains cable). Refer to the wiring diagram for more information.

▶ To prevent parasite heating, ensure that the cable cross-sections are correct and the connectors are properly tightened.

**IMPORTANT : This device is not protected against battery polarity reversals. A battery connection error automatically causes the battery fuses to blow as well as irreversible damage to the circuit board.**



## Activation precautions

▶ To prevent any risk of electric shock on activation or during operation, the protective cover must be correctly positioned and screwed into the housing.

▶ This device complies with the applicable regulations governing transmitted interference and immunity from external disturbances (see EMC paragraph in the Technical specifications section).

▶ When in operation, take particular care that this device is not subjected to conducted or radiated interference at levels higher than the legal limits otherwise malfunctions may occur (e.g.: device too close to a powerful transmitter).

▶ In other respects, this device transmits conducted and radiated interference at levels that comply with the applicable regulations. Ensure that other sensitive equipment used in the vicinity is compatible with this device otherwise malfunctions may occur.

NOT-DOLPROHD-03

## Device serial number

The serial number appears on the grey or white sticker on one side of the device. This number is aligned vertically and comprises a first number indicating the year of manufacture (e.g.: 15 for 2015), a letter indicating the month of manufacture (e.g.: C for the month of March), as well as a 5-figure number that is the product's individual serial number.



### **Important Note on the choice of charge curve**

It is important to note that the use of an inappropriate charging cycle for the battery technology may extensively impair or even damage the latter.

This is particularly true for cycles where the charge voltages are higher than the levels recommended by the battery manufacturers.

Example: A serious risk of overheating the batteries and releasing gases that are harmful to users' health.

Curve no. 9 is compatible with a LiFeSo4 battery provided that the battery is equipped with BMS-type battery protection (Battery Management System) within the actual battery.

In this case, refer to the battery manufacturer's recommendations for the choice of charging cycle.

# SAFETY PRECAUTIONS

NOT-DOLPROHD-03

## Maintenance precautions

To prevent any risk of electric shock during maintenance operations, ensure that the following recommendations are scrupulously observed before performing any maintenance on the device:

- ▶ All maintenance operations must only be carried out by a suitably qualified technician.
- ▶ In the event of damage to the mains leads and/or batteries, these may only be replaced by a qualified person, to avoid any danger.
- ▶ The mains power supply must be disconnected (cable or switch).
- ▶ The -DC or -BAT supply on the battery must also be disconnected to prevent any transfer of power.
- ▶ To allow the high voltage capacitors to discharge (on the circuit board), wait for 5 minutes before carrying out any work inside the housing.
- ▶ The fuses must be replaced by fuses with strictly identical characteristics and performance levels.

NOT-DOLPROHD-03

## RECEIPT OF THE PRODUCT

### Contents of the packaging



▶ The charger.

▶ Its user manual.

▶ Its mains cable grommet accompanied by its mounting nut (to be installed on the housing prior to connection).



▶ Its battery temperature sensor.



### Checking



Check the product's identification label, attached to one side of the product, to ensure that the technical details actually meet your needs (mains supply voltage, charger capacity, etc.).

### Installation introduction

The charger is attached using 4 x 4mm Ø screws (not supplied), to a “robust” mounting or wall.

Ideally, the product should be in a vertical position, with the cable outlet pointing downwards. Clearance of at least 10 cm must be allowed around the device to guarantee optimum convection, in particular along the sides allowing the air needed for ventilation to flow in and out.

The circulation and convection direction of the air inside the charger is from right to left, viewed from the front of the product (see photo below).

# CONNECTIONS

NOT-DOLPROHD-03

## Ventilation direction

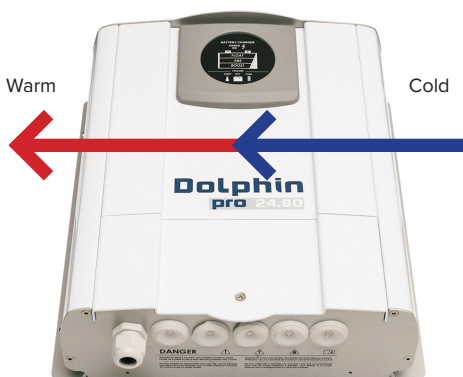

## CONNECTIONS

To gain access to the charger's connections, the front hatch must be removed. To do this, simply unscrew the screw on the front hatch. The hatch is removed by rotating it.

Prior to commencing connection, the mains cable gland must be positioned and attached to the housing in the hole designed for this purpose (hole on the left, when viewed from the front of the product).

The plastic nut supplied with the cable gland allows it to be attached to the housing. This nut is positioned on the inside of the housing. Ensure the correct tightening torque is applied.



NOT-DOLPROHD-03



## DETAILS OF CONNECTIONS

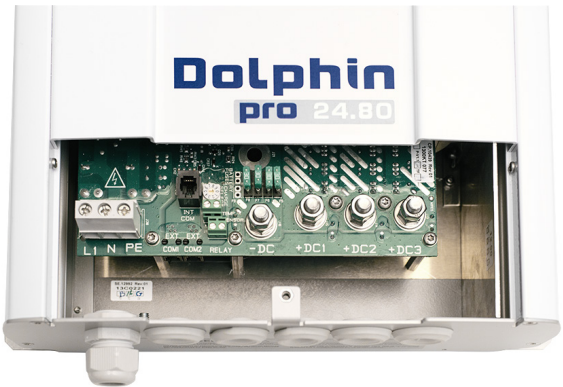

# CONNECTIONS

NOT-DOLPROHD-03

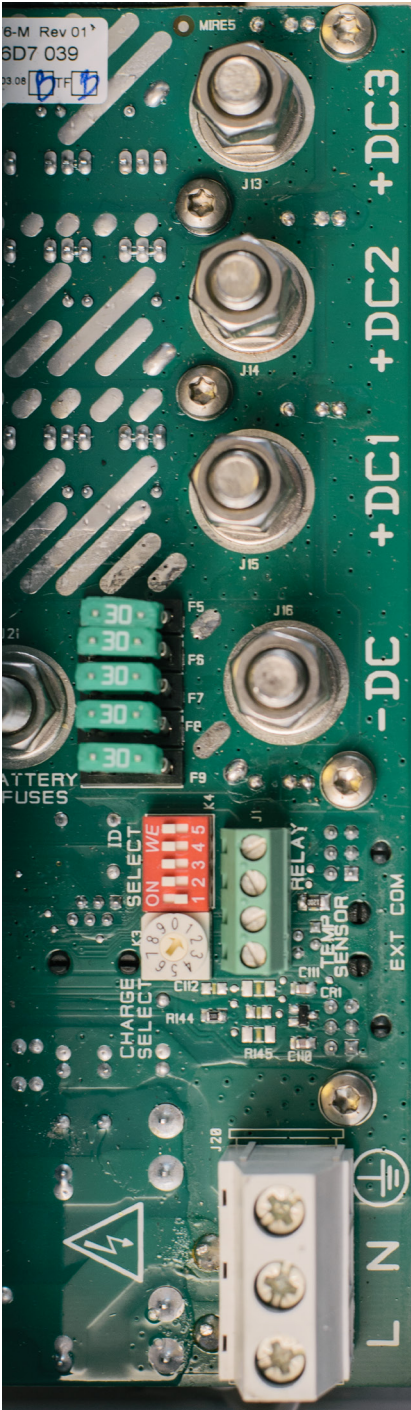

NOT-DOLPROHD-03

Marking	Functionalities
L1	AC mains phase, 10mm <sup>2</sup> max (wire colour code: brown or black)
N	AC mains neutral, 10mm <sup>2</sup> max (wire colour code: blue, white or red)
	AC mains earth, 10mm <sup>2</sup> max (wire colour code: green & yellow or green)
-DC	battery negative (common), pin M8 (wire colour code: black)
+DC1	Main battery positive, pin M8 (wire colour code: red)
+DC2	Auxiliary battery 2 positive, pin M8 (wire colour code: red)
+DC3	Auxiliary battery 3 positive, pin M8 (wire colour code: red)
CHARGE SELECT	Charge curve and battery charging mode selector, 10 positions (from 0 to 9)
BATTERY FUSES	Battery protection fuses (on the -DC supply)
EXT COM1	External communication bus (CAN bus) (for an external digital display or communication between chargers)
EXT COM2	External communication bus (CAN bus) (for an external digital display or communication between chargers)
INT COM	Communication bus for a digital display built into the charger
TEMP SENSOR	Battery temperature sensor (2 non-polarised wires, no direction) positioned on the positive terminal of the main battery
REPLAY	Dry alarm contact

# CONNECTIONS

NOT-DOLPROHD-03

## AC CABLES AND CIRCUIT BREAKER

### AC wiring

Check the quality of connections and proper tightening of connections.

For mains power, preferably use a HO7RNF-type industrial cable. Ensure that you comply with the following recommendations.

Charger capacity	230VAC 50Hz Length < 5m (16ft)	115VAC 60Hz Length < 5m (16ft)
24V 40A	2.5mm <sup>2</sup> / AWG13	4mm <sup>2</sup> / AWG11
24V 60A	2.5mm <sup>2</sup> / AWG13	4mm <sup>2</sup> / AWG11
24V 100A	4mm <sup>2</sup> / AWG11	6mm <sup>2</sup> / AWG9

### AC circuit breaker

The AC mains power line must feature a cut-off device with differential protection, to specifically protect individuals against electric shocks. The circuit breaker's sensitivity must be 30mA.

Its current capacities comply with the charger's power consumption. Comply with the following recommendations in this respect.

Charger capacity	Mains power 230V 50Hz	Mains power 115V 60Hz
24V 40A	8A – 30mA	16A – 30mA
24V 60A	10A – 30mA	20A – 20mA
24V 100A	20A – 30mA	-

**Nota:** The charger has an internal protection fuse on the L1 supply, in the event of a general fault on the circuit board in particular. Due to the irreversible nature of this fault, the fuse is not accessible for maintenance of any kind.

NOT-DOLPROHD-03

## DC CABLES AND FUSES

### DC wiring

Check the quality of connections and proper tightening of connections.

Battery cables must be as direct and short as possible. Each battery output can provide the charger's full amperage and all the cables must have identical cross-sections. Ensure that you comply with the following recommended cross-sections.

Charger capacity	Length < 2m (6ft)	Length between 3 and 5m (10 to 16ft)
24V 40A	16mm <sup>2</sup> / AWG5	20mm <sup>2</sup> / AWG4
24V 60A	25mm <sup>2</sup> / AWG3	35mm <sup>2</sup> / AWG2
24V 100A	35mm <sup>2</sup> / AWG2	50mm <sup>2</sup> / AWG0-1

These chargers are equipped with airtight grommets with “automatic” opening.

Simply pressing the central section of the membrane is sufficient to allow the cable to pass through the grommet.

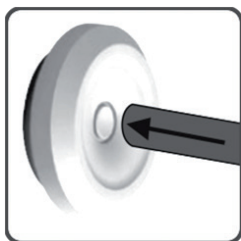

# CONNECTIONS

NOT-DOLPROHD-03

## AC CABLES AND CIRCUIT BREAKER

### DC fuses

When maintaining the charger's internal fuses, these must be replaced by fuses with strictly identical characteristics and performance levels. Risks of irreversible damage to the equipment.

It is essential and highly recommended that you install, as close as possible to each positive output on the battery, a fuse to protect connections, specifically in the event of a short circuit and/or overheating of the battery cables, as the result of damage to the protective sleeves, for example.

Charger capacity	Internal charger fuse (-DC supply)	External battery fuse (access + BAT)
24V 40A	3 x 25A 32V rapid (mini automotive fuse)	60A 32V rapid
24V 60A	3 x 25A 32V rapid (mini automotive fuse)	80A 32V rapid
24V 100A	5 x 30A 32V rapid (mini automotive fuse)	150A 32V rapid

## CHARGE CURVE SELECTION

The up-to-date digital electronics, based on an RSC microcontroller, monitor the charging process by optimising, the voltage, current and recharging time parameters, on the basis of the initial charge level of the batteries, using the exclusive "scanning charge" function.

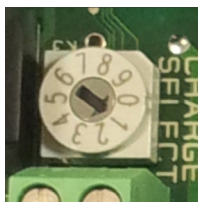

NOT-DOLPROHD-03

The performance and usable life of batteries are thereby maximised.

By virtue of fully automated charging cycles, the batteries are protected against surges, providing a permanent connection for the charger.

Selection of the charging program takes place on installation using the "CHARGE SELECT" dial on the charger board.

The position of the arrow indicates the number of the program selected (e.g.: program No. 1 in the photograph above). Selection is made using a small flat-head screwdriver.



## CAUTION

It is important to note that the use of an inappropriate charging cycle for the battery technology may extensively impair or even damage the latter.

This is particularly true for cycles where charge voltages are higher than the levels recommended by the battery manufacturers.

A serious risk of overheating the batteries and releasing gases that are harmful to users' health.



Curve no. 9 is compatible with a LiFeSo4 battery, provided that the battery is equipped with BMS-type battery protection (Battery Management System) within the actual battery.

In this case, refer to the battery manufacturer's recommendations for the choice of charging cycle.





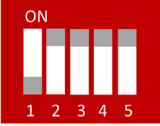

# CONNECTIONS

NOT-DOLPROHD-03

## NETWORK MODE

<p>Dipswitch</p> 	<p><b>Position 1</b> : Status of the battery charger, Master or Slave. Only 1 Master per ID battery.</p> <p><b>Positions 2 3 4</b> : ID battery. In other words, a group of battery chargers connected to a same battery. Slave battery chargers connected to a Master must have the same ID battery.</p> <p><b>Position 5</b> : End 120Ω resistor connected to ON if the battery charger is at the beginning or the end of the CANbus.</p>
<p>Rotary selector</p> 	<p><b>Master</b> battery charger : Fixed the charge cycle of the Master and the different Slave battery chargers connected to a same battery.</p> <p><b>Slave</b> battery charger : Fixed the ID charger connected to a same battery</p>

### Example 1: THREE battery chargers connected to a same battery



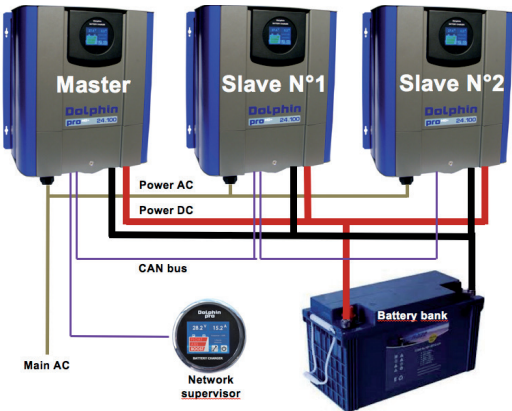

Master charger		Slave charger N°1		Slave charger N°2	
Dipswitch	Rotary selector	Dipswitch	Rotary selector	Dipswitch	Rotary selector
					
<p>1 : Master 2 3 4 : ID battery 5 : 120Ω On</p>	<p>Cycle charge (10 positions)</p>	<p>1 : Slave 2 3 4 : ID battery (refer to Master) 5 : 120Ω Off</p>	<p>ID Slave N°1 (ex, position 1)</p>	<p>1 : Slave 2 3 4 : ID battery (refer to Master) 5 : 120Ω On</p>	<p>ID Slave N°2 (ex, position 2)</p>





NOT-DOLPROHD-03

**Example 2:** TWO battery chargers connected to 2 different batteries

Master charger 1		Master charger 2	
Dipswitch	Rotary selector	Dipswitch	Rotary selector
			
1 : Master 2 3 4 : ID battery 5 : 120Ω On	Cycle charge (10 positions)	1 : Master 2 3 4 : ID battery 5 : 120Ω On	Cycle charge (10 positions)

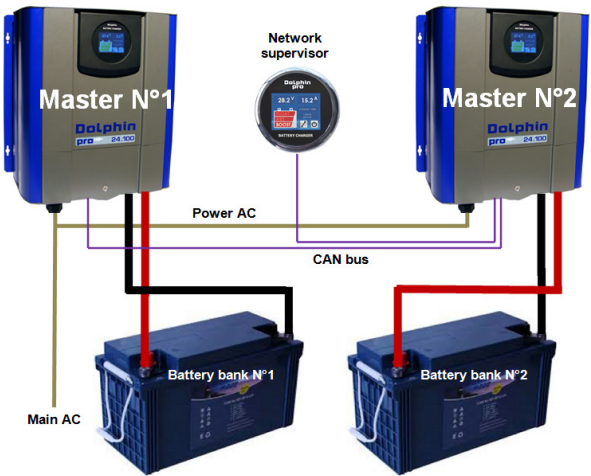

**Example 3:** Case of the 24V100A model (battery charger with 2 power PCB)

Same setup with examples 1 & 2 except for the bottom power PCB :

- Same ID battery with the top power PCB
- Rotary selector on position 0
- 120Ω CAN resistor on position Off

# SETTINGS

NOT-DOLPROHD-03

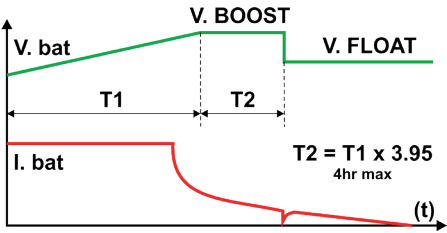
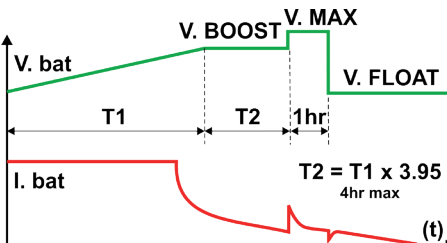
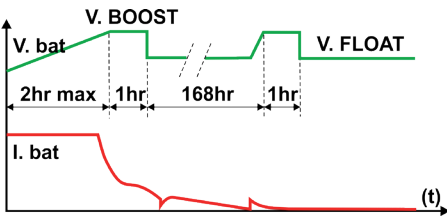
PROGRAMME		PHASE	VOLTAGE
0	Open lead <b>Dolphin First</b>	V. BOOST V. FLOAT	28,8V 26,4V
1	Airtight lead	V. BOOST V. FLOAT	28,4V 27,2V
2	Lead calcium <b>Dolphin Pro</b>	V. BOOST V. FLOAT	29,6V 27,6V
3	«Delphi» type	V. BOOST V. FLOAT	30,8V 27,6V
Charge curve			
4	«Optima» type	V. BOOST V. MAX V. FLOAT	29,6V 31,0V 27,6V
Charge curve			
5	Wintering Open lead	V. BOOST V. FLOAT	28,8V 26,4V
Charge curve			

NOT-DOLPROHD-03

6	Odyssey	V. BOOST V. FLOAT	28,4V 27,2V
7	GEL & AGM	V. BOOST V. FLOAT	28,8V 27,6V
Charge curve		<p><b>V. bat</b> <b>V. BOOST</b> <b>V. FLOAT</b></p> <p><b>I. bat</b> <math>T2 = T1 \times 3.95</math> 4hr max</p> <p>(t)</p>	
8	Power supply	V. FLOAT	27,2V
9	LiFeSo4 + integrated BMS	V. FLOAT	28,8V
Charge curve		<p><b>V. bat</b> <b>V. FLOAT</b></p> <p><b>I. bat</b> (t)</p>	

# OPERATION

NOT-DOLPROHD-03

## BATTERY TEMPERATURE SENSOR

The temperature sensor allows the charging voltage to be adjusted depending on the battery temperature.

It therefore allows the usable life of batteries to be increased, mainly in the event that the ambient temperature in the battery area is high.

This sensor is screwed onto the main battery's positive terminal (a service battery as a general rule). The 2 wires are connected to the "TEMP SENSOR" connector on the charger board (in no particular direction).

The compensation level is around +/-25mV per °C for a 24V battery and between +/-12mV per °C for a 12V battery (see curves below).

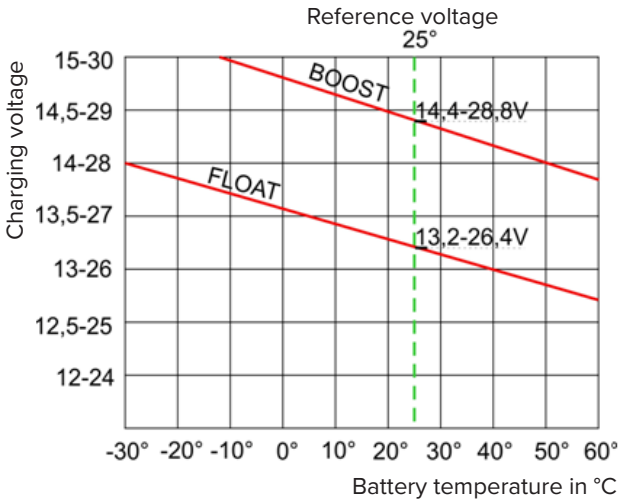

NOT-DOLPROHD-03

## TOUCH DISPLAY

This HD+ charger is equipped with an interactive colour TOUCH screen. Screen functions are described below.

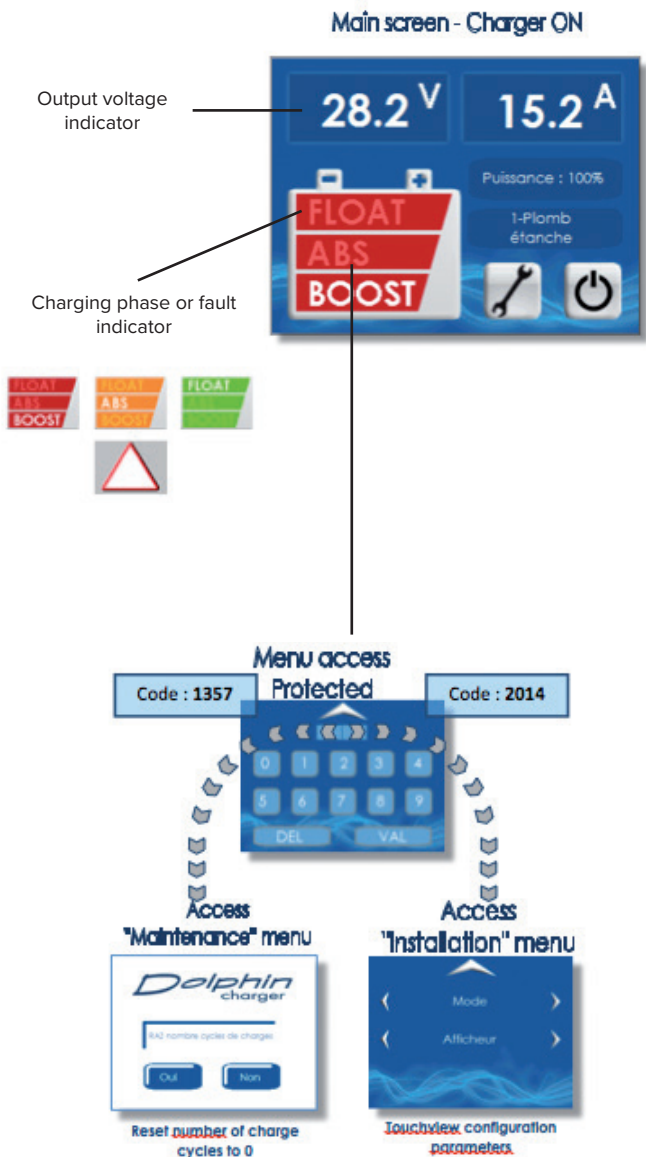

# OPERATION

NOT-DOLPROHD-03

## Main screen - Charger ON



Output current

Charger power

Charger power

Screen mode: display

Charging cycle time

Alternating current

Network/Cellular

## Access to "Function" menu



## Access to "Setup" menu

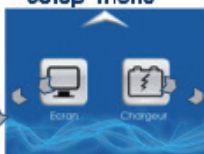

## Access to "Supervisor" menu



Display charger data

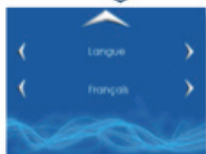

Display configuration parameters



Charger configuration parameters

Selecting a function:



Back to previous page:



Select previous parameter:



NOT-DOLPROHD-03

## Charger OFF



3-voltage display  
**Battery.**

- > If in "Controller" mode: **Press on screen** to restart charger
- > In "Display" mode: **main screen displayed automatically** if charger restarts.

## Access to charger OFF command



## Access to "Help" menu



Description of charge phases



Description of faults and fault clearing conditions



Description of selecting type of charge cycle



Touchview product version

Select next parameter



# TECHNICAL SPECIFICATIONS

NOT-DOLPROHD-03

## Technical specifications

	24V 40A	24V 60A	24V 100A
<b>MAINS POWER CHARACTERISTICS</b>			
Mains voltage	115V 60Hz et/ou 230V 50Hz (+/-15%)		230V (+/-15%)
Power factor	0,9typ.		
Efficiency	87 typ.		
Inrush current	< 30A, limited by soft start		< 60A
Consumption	14A/6A	15A/9A	15A
Active power	1350VA	2000VA	3500VA
Derating @ 115V	Without derating	70% P <sub>nom</sub>	-
Mains power fuse	T20A (6.3x32 mm)	T20A (6.3x32 mm)	2xT20A (6,3x32 mm)
<b>BATTERY CHARGING CHARACTERISTICS</b>			
Number of outputs	3 independent supplies		
Number of cycles	10 charging cycles (from 0 to 9), setting by means of a dial		
Charge curves	In general 3 statuses, type I.U.Uo		
Open lead	V.BOOST = 28.8V V.FLOAT = 26.4V		
Airtight lead	V.BOOST = 28.4V V.FLOAT = 27.2V		
Lead calcium	V.BOOST = 29.6V V.FLOAT = 27.6V		
«Delphi» Type	V.BOOST = 30.8V V.FLOAT = 27.6V		
«Optima» Type	V.BOOST = 29.6V then 31.0V V.FLOAT = 27.6V		
Wintering open lead	V.BOOST = 28.8V V.FLOAT = 26.4V		
Wintering airtight lead	V.BOOST = 28.4V V.FLOAT = 27.2V		



NOT-DOLPROHD-03

	24V 40A	24V 60A	24V 100A
Gel & AGM	V.BOOST = 28.8V V.FLOAT = 27.6V		
Power supply	V.FLOAT = 27.2V		
LifeSo4 + integrated BMS	V.FLOAT = 28.8V		
Temperature compensation	+/-25mV / °C (by an external sensor)		
Voltage tolerance	+/-2%		
Ripple	< 1 % (BW < 20 Mhz)		
Maximum current	40A (+/-5%)	60A (+/-5%)	100A (+/-5%)
Supply fuse -DC	3 x F25A (miniature automotive fuse)		5 x 30A (miniature automotive fuse)
<b>PROTECTION</b>			
Output surge	"Current limited" type		
Output short circuit	"Shutdown" type with automatic restart once the fault has disappeared		
Excessive output voltage	"Shutdown" type with automatic restart once the fault has disappeared		
Battery polarity reversal	Output fuse		
Excessive internal temperature	"Shutdown" type with automatic restart once the fault has disappeared		
Excessive battery temperature	"Shutdown" type with automatic restart once the fault has disappeared		
Temperature sensor out of service	"Shutdown" type with automatic restart once the fault has disappeared		
Mains power supply general fault	Mains power fuse		
Battery supply general fault	Output fuses on -DC supply		
Climatic conditions	Tropicalised electronics board		

# TECHNICAL SPECIFICATIONS

NOT-DOLPROHD-03

	24V 40A - 24V 60A	24V 100A
<b>GENERAL INFORMATION</b>		
Operating temperature	-10°C to +55°C	
Storage temperature	-20°C to +70°C	
Humidity	10% to 90% (without condensation)	
Convection	Forced by thermostat-controlled fan	
Case	Wall-mounted case in painted aluminium	
Protection rating	IP22	
Mounting	Using 4 x 4mm Ø screws	
Overall dimensions (Depth x Width x Height)	128x346x358 mm	196x346x 358 mm
Weight	6 Kg	11,5 kg
Display	TOUCH colour screen	
Mains connector	3-point cage terminal for cables with a cross-section of 10mm <sup>2</sup> max	
Battery connectors	M8 pins	
Battery sensor connector	2-point cage terminal for cables with a cross-section of 1.5mm <sup>2</sup> max	
Alarm relay connector	2-point cage terminal for cables with a cross-section of 1.5mm <sup>2</sup> max	
External CAN bus connectors	Micro-Fit (qte 2) & RJ11 (qte 1)	
<b>STANDARDS</b>		
EMC	EN55016-2-1, EN55016-2-1/A1, CISPR 16-2-1 EN 55016-2-3 + EN 55016-2-3/A1 IEC 61000-4-3 + A1 + A2 IEC 61000-4-2 IEC 61000-4-6 IEC 61000-4-5 IEC 61000-4-4	
Environment	IEC 60068-2-30 & IEC 60068-2-1 (climatique) IEC 60068-2-52 (brouillard salin)	
Mechanical	IEC 60068-2-6 & IEC 60068-2-64 (vibrations) test IEC publication N°60529 (IP)	
SAFETY	EN 60335-1	
DNV	Classification «Control room, Accomodation»	



NOT-DOLPROHD-03

## Dimensions

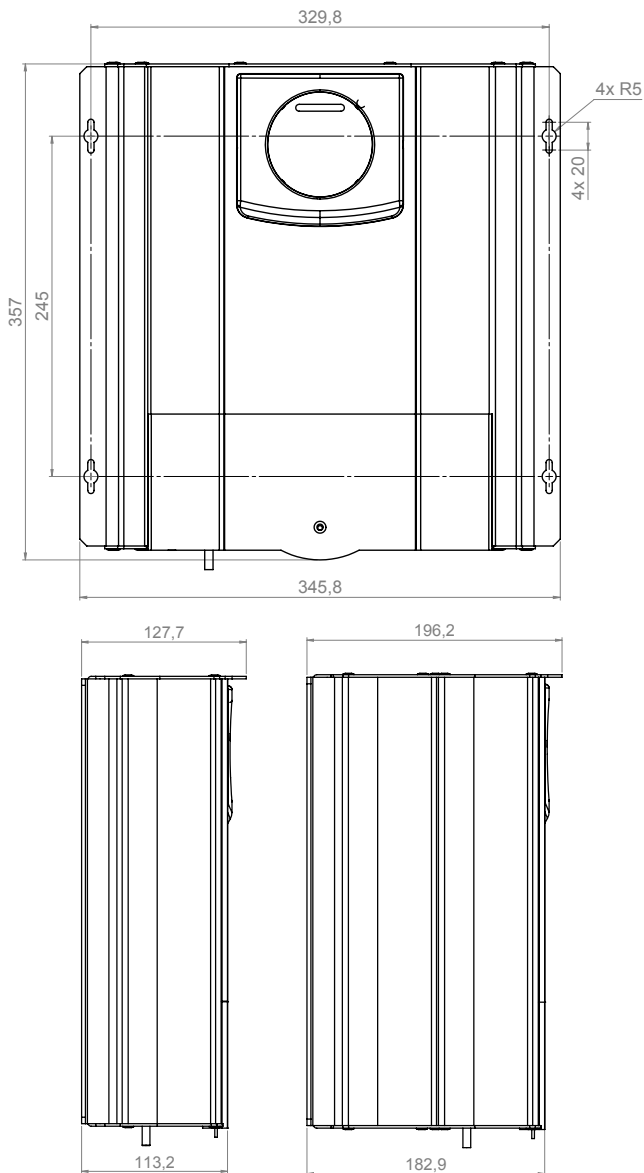

Check that the mounting screws used are compatible with the type of mounting wall (resin, wood, metal, etc.). The charger should be positioned against the wall and mounted firmly.

# WARRANTY

NOT-DOLPROHD-03

## Warranty

**TO PREVENT ANY RISK OF INCORRECT USE OF THE DEVICE, CAREFULLY READ THE LIST OF POTENTIAL EVENTS OR FAULTS NOT COVERED BY THE PRODUCT WARRANTY**

- ▶ This device is not protected against battery polarity reversals. Risk of irreversible damage to the equipment.
- ▶ Should the device be dropped or fall this could cause irreversible distortion of the housing as well as a “crash” of internal fans and certain electronic components.
- ▶ Modifications to the housing (additional holes in particular) could result in the scattering of swarf or metal filings onto the circuit board and, consequently, in malfunctions or irreversible damage to the equipment.
- ▶ Interference with or modifications to the circuit board could result in operating modes not originally anticipated, and consequently, in malfunctions or irreversible damage to the equipment.
- ▶ Powering the device from an unsuitable energy source (as a general rule, mains supply voltage that is too high).
- ▶ Accidental original mains supply surge or lightning strike generally causing irreversible damage to the equipment.
- ▶ Replacement of fuses with fuses with different characteristics that could cause irreversible damage to the equipment.
- ▶ Obvious connection errors causing irreversible damage to the equipment.
- ▶ Water spray or running water inside the device that could result in irreversible electronic malfunctions.

NOT-DOLPROHD-03

## **Precautions for scrapping**

This device contains electronic components and materials that must be recycled at the end of the product's usable life, for environmental reasons.

At the end of their usable lives all devices must therefore be returned either to the local distributor or entrusted to a specialist electronic equipment recycling company.

## **EC compliance**

This device complies with the applicable European standards and has an EC mark. Its certificate of compliance is available on request.

**Dolphin**  
charger



[info@dolphin-charger.com](mailto:info@dolphin-charger.com)  
[www.dolphin-charger.com](http://www.dolphin-charger.com)