

# RIGGING & HARDWARE 10

## HARDWARE

Stainless Steel Fasteners.....	10.02 - 10.03
Press Stud Buttons & Eylets.....	10.11
Press Stud Tool .....	10.11

## SHACKLES, SWIVELS & HOOKS

Swivel Connectors .....	10.04
Shackles .....	10.04 - 10.06
Swivel Shackles.....	10.06
Snap Hooks .....	10.06 - 10.07
Turnbuckles .....	10.08

## RIGGING ACCESSORIES

Eye Bolts .....	10.08
Wire Rope Clamps .....	10.08
U Bolts .....	10.08
S Hooks.....	10.08
Rings .....	10.09
Eye Plates .....	10.09
Pad Eyes .....	10.10
Saddle Eye Straps.....	10.10
Thimbles.....	10.10
Shockcord Hooks .....	10.11

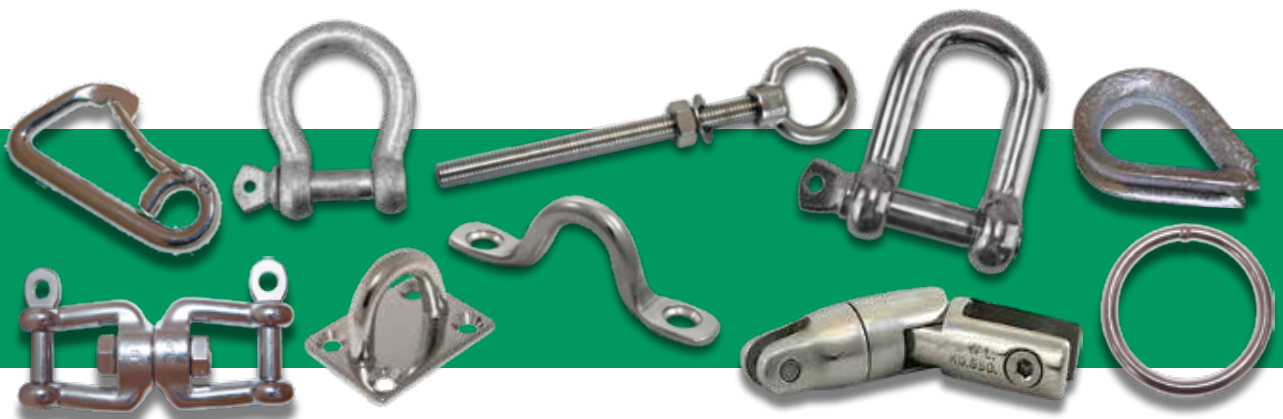

## AQUAPAC Stainless Steel Fasteners

Marine 304-grade stainless-steel fasteners sold in convenient small pre packed quantities for retail sale or workshop use. Packaged in hanging display self-serve packs.

**Note: Packs are bundled and sold in multiples of 5.**

### Hex Head Bolt



Part No.	Dia (in)	Length		Qty per pack
		(mm)	(in)	
910010	1/4	25	1	4
910011	1/4	38	1 1/2	4
910012	1/4	51	2	2
910013	1/4	64	2 1/2	2
910014	1/4	76	3	2
910019	5/16	25	1	4
910020	5/16	38	1 1/2	2
910021	5/16	51	2	2
910022	5/16	64	2 1/2	2
910023	5/16	76	3	2
910030	3/8	38	1 1/2	2
910031	3/8	51	2	2
910032	3/8	64	2 1/2	2
910033	3/8	76	3	2

### Round Head Screws - Metal Thread



Part No.	Dia (in)	Length		Qty per pack
		(mm)	(in)	
910040	3/16	19	3/4	8
910041	3/16	25	1	6
910042	3/16	38	1 1/2	6
910043	3/16	51	2	4
910044	3/16	64	2 1/2	2
910045	3/16	76	3	2
910050	1/4	19	3/4	6
910051	1/4	25	1	6
910052	1/4	38	1 1/2	4
910053	1/4	51	2	2
910054	1/4	64	2 1/2	2
910055	1/4	76	3	2

### Countersunk Screws - Metal Thread



Part No.	Dia (in)	Length		Qty per pack
		(mm)	(in)	
910060	3/16	19	3/4	8
910061	3/16	25	1	6
910062	3/16	38	1 1/2	6
910063	3/16	51	2	4
910064	3/16	64	2 1/2	2
910065	3/16	76	3	2
910070	1/4	19	3/4	6
910071	1/4	25	1	6
910072	1/4	38	1 1/2	4
910073	1/4	51	2	2
910074	1/4	64	2 1/2	2
910075	1/4	76	3	2

### Countersunk Screws - Metal Thread, Nut & Washer



Part No.	Dia (in)	Length		Qty per pack
		(mm)	(in)	
910066	3/16	25	1	4
910067	3/16	38	1 1/2	4
910068	3/16	51	2	4
910076	1/4	25	1	4
910077	1/4	38	1 1/2	4
910078	1/4	51	2	2

### Round Head Screws - Metal Thread, Nut & Washer



Part No.	Dia (in)	Length		Qty per pack
		(mm)	(in)	
910046	3/16	25	1	4
910047	3/16	38	1 1/2	4
910048	3/16	51	2	4
910056	1/4	25	1	4
910057	1/4	38	1 1/2	4
910058	1/4	51	2	2

### Pan Head Screws - Self Tapper



Part No.	Dia (gauge)	Length		Qty per pack
		(mm)	(in)	
910080	6	13	1/2	15
910081	6	19	3/4	15
910082	6	25	1	15
910083	6	32	1 1/4	10
910084	6	38	1 1/2	10
910085	8	13	1/2	15
910086	8	19	3/4	15
910087	8	25	1	12
910088	8	32	1 1/4	10
910089	8	38	1 1/2	8
910090	10	13	1/2	12
910091	10	19	3/4	12
910092	10	25	1	10
910093	10	32	1 1/4	8
910094	10	38	1 1/2	8
910095	12	19	3/4	6
910096	12	25	1	6
910097	12	32	1 1/4	6
910098	12	38	1 1/2	4
910099	12	51	2	4

### Wing Nuts



Part No.	Type	Size (in)	Qty per pack
910150	UNC	3/16	2
910151	UNC	1/4	2
910152	UNC	5/16	2
910153	UNC	3/8	1

### Dome Nuts



Part No.	Type	Size (in)	Qty per pack
910155	UNC	3/16	2
910156	UNC	1/4	2
910157	UNC	5/16	2
910158	UNC	3/8	2

**Countersunk Screws - Self Tapper** 

Part No.	Dia (gauge)	Length		Qty per pack
		(mm)	(in)	
910105	6	13	1/2	15
910106	6	19	3/4	15
910107	6	25	1	15
910108	6	32	1 1/4	10
910109	6	38	1 1/2	10
910110	8	13	1/2	15
910111	8	19	3/4	15
910112	8	25	1	12
910113	8	32	1 1/4	10
910114	8	38	1 1/2	8
910115	10	13	1/2	12
910116	10	19	3/4	12
910117	10	25	1	10
910118	10	32	1 1/4	8
910119	10	38	1 1/2	8
910120	12	13	3/4	6
910121	12	25	1	6
910122	12	32	1 1/4	6
910123	12	38	1 1/2	4
910124	12	51	2	4

**Hex Nuts** 

Part No.	Type	Size (in)	Qty per pack
910140	BSW	3/16	12
910141	UNC	1/4	10
910142	UNC	5/16	6
910143	UNC	3/8	4

**Nyloc Nuts** 

Part No.	Type	Size (in)	Qty per pack
910130	BSW	3/16	8
910131	UNC	1/4	6
910132	UNC	5/16	4
910133	UNC	3/8	2

**Cup Washers** 

Part No.	Inside Diameter		Qty per pack
	(gauge)	(mm)	
910185	6	3.5	10
910186	8	4.2	10
910187	10	4.8	6
910188	12	5.5	6

**Spring Washers** 

Part No.	Diameter		Qty per pack
	(mm)	(in)	
910180	4.8	3/16	20
910181	6.4	1/4	15
910182	7.9	5/16	10
910183	9.5	3/8	8

**Washer - Small** 

Part No.	Diameter (in)		Qty per pack
	Inside	Outside	
910160	3/16	7/16	20
910161	1/4	1/2	15
910162	5/16	3/4	15
910163	3/8	3/4	10

**Washer - Large** 

Part No.	Diameter (in)		Qty per pack
	Inside	Outside	
910165	3/16	3/4	15
910166	1/4	3/4	12
910167	5/16	3/4	10
910168	3/8	1	8

**Plastic Stay Put Fasteners** 

Part No.	Type	Colour	Qty per pack
916520	Single Horizontal	White	2
916521	Single Horizontal	Black	2
916522	Double Horizontal	White	2
916524	Single Vertical	White	2
916525	Single Vertical	Black	2
916526	Double Vertical	White	2

**Rivets - Aluminium** 

Part No.	Size	Qty per pack
911642	4 - 2	15
911644	4 - 4	15
911645	4 - 5	15
911646	4 - 6	15
911652	5 - 2	15
911654	5 - 4	12
911656	5 - 6	12
911664	6 - 4	12
911666	6 - 6	10
911668	6 - 8	8

**Rivets - Stainless Steel** 

Part No.	Size	Qty per pack
911742	4 - 2	10
911743	4 - 3	10
911744	4 - 4	10
911752	5 - 2	8
911754	5 - 4	8
911756	5 - 6	6
911764	6 - 4	5
911766	6 - 6	4
911768	6 - 8	4

**Split Pins** 

Part No.	Dia. (mm)	Length (mm)	Qty per pack
910220	2	20	8
910221	2.5	20	6
910222	2.5	25	6
910223	2.5	32	4
910224	3.2	20	4
910225	3.2	25	4
910226	3.2	32	4
910227	3.2	40	4
910228	4	25	3
910229	4	32	2
910230	4	40	2

### Anchor Single Swivel Connectors - Stainless Steel

Single swivel anchor to chain connectors.  
 • Made from 316-grade stainless steel.  
 • Slides over bow rollers for easy retrieval.

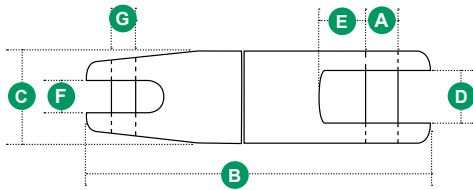

\* SWL (safe working load) is approx 25% of breaking load.

Part No.	Suits Chain (mm)	Dimensions (mm)							SWL* (kg)
		øA	B	C	D	E	F	G	
JPW4921	6-8	9	90	27	15	23	10	7	850
JPW4922	10-12	10.5	115	35	18	30	14	10.5	1350

### Anchor Double Swivel Connectors - Stainless Steel

Double swivel anchor to chain connectors made from 316-grade stainless steel. Prevents chain and anchor from twisting when setting and retrieving anchor.  
 • Slides over bow rollers for easy retrieval.

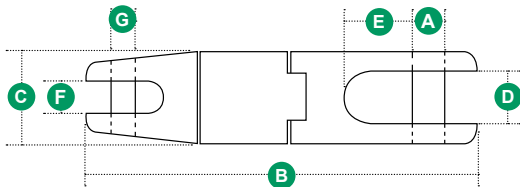

\* SWL (safe working load) is approx 25% of breaking load.

Part No.	Suits Chain (mm)	Dimensions (mm)							SWL* (kg)
		øA	B	C	D	E	F	G	
JPW4926	6-8	9	133	28	16	21	9	7	850
JPW4927	10-12	10.5	168	38	18	28	14	10.5	1350

### Bow Shackles - Galvanised

Screw collar pin drilled with hole for security tie wire.  
 • For general use, not rated for lifting.

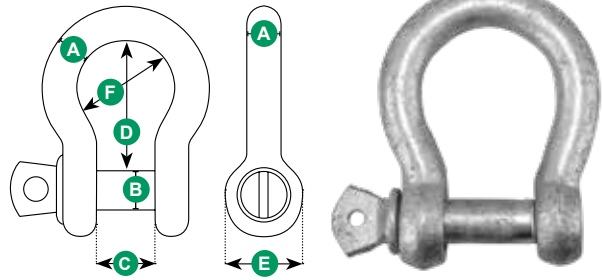

\* SWL (safe working load) is approx 25% of breaking load.

Part No.	Dimensions (mm)						SWL* (kg)
	øA	øB	C	D	E	F	
JPW592	6	6	14	25	12	19	80
JPW592B	As above (Bag of 200)						
JPW593	8	8	16	32	15	24	100
JPW593B	As above (Bag of 200)						
JPW594	10	10	20	39	18	29	200
JPW594B	As above (Bag of 200)						
JPW595	12	12	25	46	22	35	300
JPW595B	As above (Bag of 100)						
JPW596	14	14	27	60	26	43	500
JPW596B	As above (Bag of 100)						
JPW597	16	16	29	65	26	47	650
JPW598	20	20	35	76	32	58	800
JPW599	25	25	46	104	42	77	1100

### Bow Shackles - Stainless Steel

316-grade stainless steel. Screw collar pin drilled with hole for security tie wire.

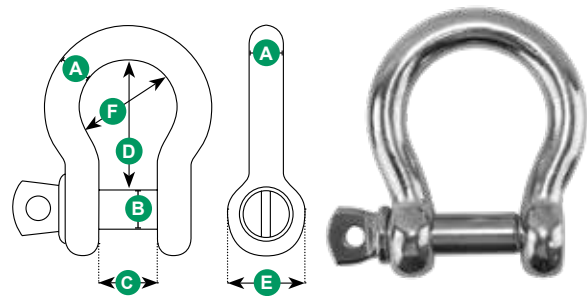

\* SWL (safe working load) is approx 25% of breaking load.

Part No.	Dimensions (mm)						SWL* (kg)
	øA	øB	C	D	E	F	
JPW4882	5	5	10	19	10	15	250
JPW4883	6	6	12	24	12	18	375
JPW4884	8	8	16	32	16	24	625
JPW4885	10	10	22	40	20	30	1000
JPW4886	12	12	25	45	24	38	1600
JPW4887	16	16	32	62	32	56	1750
JPW4888	20	20	38	76	41	66	1900
JPW4889	25	25	50	102	48	87	2200

### D Shackles - Galvanised

For general use, not rated for lifting. Screw collar pin drilled with hole for security tie wire.

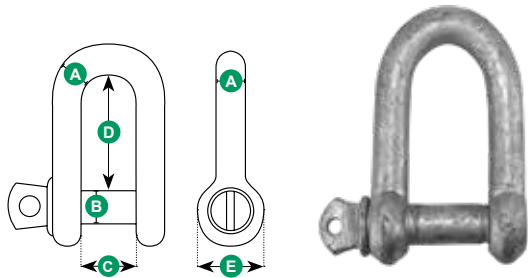

\* SWL (safe working load) is approx 25% of breaking load.

Part No.	Dimensions (mm)					SWL* (kg)
	Ø A	Ø B	C	D	E	
JPW550	5	5	10	19	10	-
JPW550B	As above (Bag of 200)					
JPW551	6	6	13	25	12.5	80
JPW551B	As above (Bag of 200)					
JPW552	8	8	18	32	15.5	100
JPW552B	As above (Bag of 200)					
JPW553	10	10	19	37	18.5	200
JPW553B	As above (Bag of 200)					
JPW554	12	12	26	47	24	300
JPW554B	As above (Bag of 100)					
JPW555	16	16	30	61	30	500
JPW555B	As above (Bag of 100)					
JPW556	20	20	35	72	34	800
JPW556B	As above (Bag of 100)					
JPW557	25	25	49	94	44.5	1100
JPW557B	As above (Bag of 100)					

### D Shackles - Stainless Steel

316-grade stainless steel. Solid round standard screw pin with hole for security tie wire.

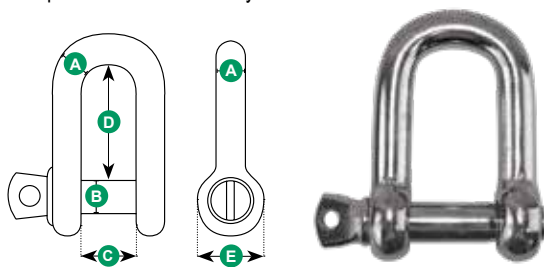

\* SWL (safe working load) is approx 25% of breaking load.

Part No.	Dimensions (mm)					SWL* (kg)
	Ø A	Ø B	C	D	E	
JPW4872	5	5	10	18	9.5	250
JPW4873	6	6	11	24	13.5	375
JPW4874	8	8	17	33	15.5	625
JPW4875	10	10	20	40	19.5	1000
JPW4876	12	12	23	48	24.5	1500
JPW4877	16	16	34	64	30.5	2750
JPW4878	20	20	40	76	39	3750

### D Shackles - Galvanised

Load rated galvanised steel with yellow pin.

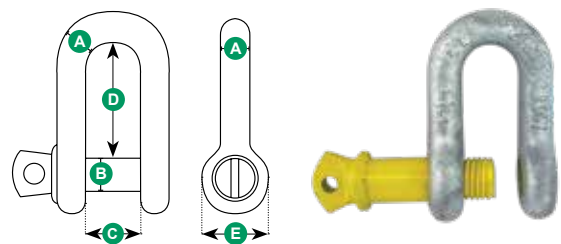

\* SWL (safe working load) is approx 25% of breaking load.

Part No.	Dimensions (mm)				SWL* (kg)
	ØA	ØB	C	D	
JPW6692	9	9.5	12	25	750
JPW6694	10	11	16	31	1000
JPW6697	12	13	18	36	1500
JPW6699	14	16	20	40	2000

### Captive Pin D Shackles - Stainless Steel

316-grade stainless steel with captive pin.

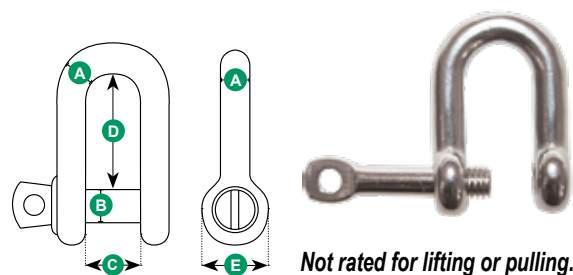

Not rated for lifting or pulling.

Part No.	Dimensions (mm)				
	ØA	ØB	C	D	E
JPW4890	5	10	18	11	10
JPW4891	6	13	24	14	12
JPW4892	8	17	26	16	16
JPW4893	10	21	36	20	20

### Long 'D' Shackles - Stainless Steel

316-grade stainless steel with solid round standard screw pin and long body.

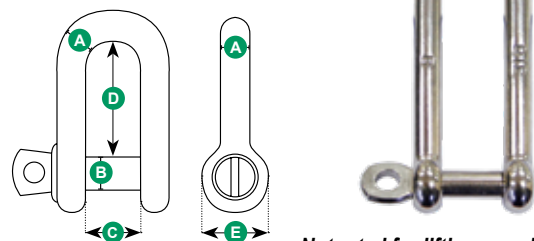

Not rated for lifting or pulling.

Part No.	Dimensions (mm)			
	ØA	ØB	C	D
JPW4840	6	6	12	48
JPW4841	8	8	16	64
JPW4842	10	10	20	80
JPW4843	12	12	24	96



## Soft Rope Shackles

The soft rope shackle is made with UHMWPE (Ultra high molecular weight polyethylene) and ideal for hooking up halyards, connecting sheets or attaching blocks. It is lighter than a metal shackle without losing any strength.

Part No.	Width	Length	Breaking Strain (kg)
JPW4972	6	100	3300
JPW4973	8	100	5500
JPW4974	10	150	8100
JPW4975	12	150	12500
JPW4976	14	150	15000

- Fast, secure connection and simple to use.
- Highly resistant to abrasion.
- Locks closed when under load.
- Requires no tools to undo.

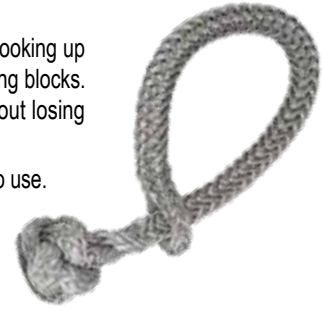

## Jaw and Jaw Swivel Shackles - Stainless Steel

316-grade stainless steel with pin at each end for easy connection.

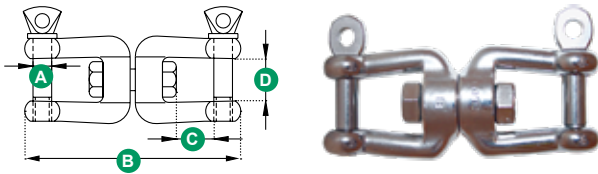

\* SWL (safe working load) is approx 25% of breaking load.

Part No.	Dimensions (mm)				SWL* (kg)
	A	B	C	D	
JPW4936	6	66	11	12	300
JPW4937	8	94	16	16	500
JPW4938	10	118	22	20	875
JPW4939	13	152	28	26	1250

## Eye Swivel Snap Shackles - Stainless Steel

Eye swivel snap shackle, made from 316-grade stainless steel.

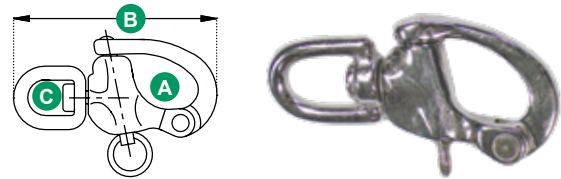

Part No.	Dimensions (mm)		
	A	B	C
JPW4915	12	70	12
JPW4916	16	87	16
JPW4917	22	128	22

## Eye and Eye Swivels - Stainless Steel

Eye and Eye heavy duty swivel, made from 316-grade stainless steel.

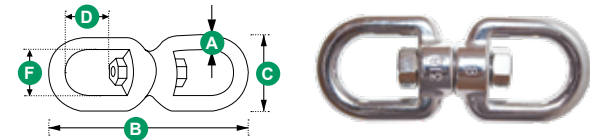

\* SWL (safe working load) is approx 25% of breaking load.

Part No.	Dimensions (mm)					SWL* (kg)
	A	B	C	E	F	
JPW4958	6	65	21	15	15	335
JPW4959	8	90	35	22	20	500
JPW4960	10	115	44	27	24	875

## Jaw Swivel Snap Shackles - Stainless Steel

Jaw swivel snap shackle, made from 316-grade stainless steel.

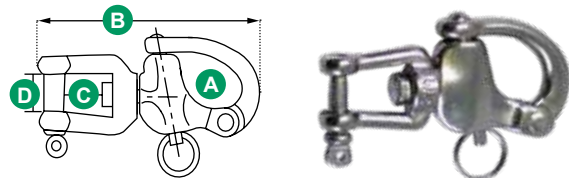

Part No.	Dimensions (mm)			
	A	B	C	D
JPW4918	16	70	12	9
JPW4919	22	87	13	11

## Eye and Jaw Swivel Shackles - Stainless Steel

Eye and Jaw swivel shackle, made from 316-grade stainless steel.

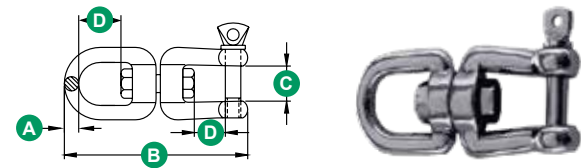

Part No.	Dimensions (mm)			
	A	B	C	D
JPW4962	6	66	11	12
JPW4963	8	94	16	16
JPW4964	10	118	22	20

## Asymmetric Snap Hooks - Stainless Steel

Asymmetric snap hook made from 316-grade stainless steel.

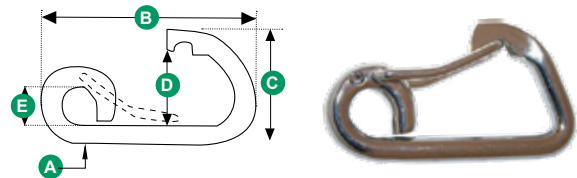

\* SWL (safe working load) is approx 25% of breaking load.

Part No.	Dimensions (mm)					SWL* (kg)
	A	B	C	D	E	
JPW4941	6	60	35	11	9	188
JPW4942	8	80	46	18	11	440
JPW4943	10	100	58	22	15	575
JPW4944	12	120	70	26	18	910

### Snap Hooks with Eye - Stainless Steel

316-grade stainless steel spring snap hook with a ferrule rope eye fixed into the formed eye.

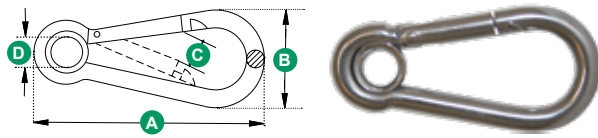

\* SWL (safe working load) is approx 25% of breaking load.

Part No.	Dimensions (mm)					SWL* (kg)
	Dia	A	B	C	D	
JPW4950	5	50	25	7	6	100
JPW4951	6	60	30	8	7	125
JPW4952	7	70	35	9	9	175
JPW4953	8	80	39	10	10	220
JPW4954	10	100	50	13	13	290
JPW4955	11	120	58	18	15	320
JPW4956	12	140	65	21	19	380

### Snap Hooks without Eye - Stainless Steel

316-grade stainless steel spring snap hook with open eye.

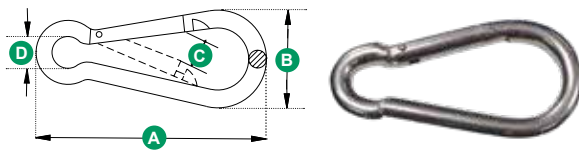

\* SWL (safe working load) is approx 25% of breaking load.

Part No.	Dimensions (mm)					SWL* (kg)
	Dia	A	B	C	D	
JPW4901	5	50	25	7	9	100
JPW4902	6	60	30	8	10	125
JPW4903	8	80	35	10	13	175
JPW4904	10	100	50	13	17	220
JPW4905	12	120	58	16	18	320
JPW4906	12	140	67	23	22	380

### Cast Snap Hooks - Stainless Steel

Cast 316-grade stainless steel. Streamlined design for snag-free operation.

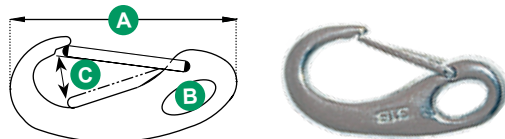

\* SWL (safe working load) is approx 25% of breaking load.

Part No.	Dimensions (mm)			SWL* (kg)
	A	B	C	
JPW4947	50	8	10	80
JPW4948	70	12	11	150
JPW4949	100	16	16	250

### Swivel Eye Snap Hooks - Stainless Steel

Swivel eye spring snap hook, made from cast 316-grade stainless steel.

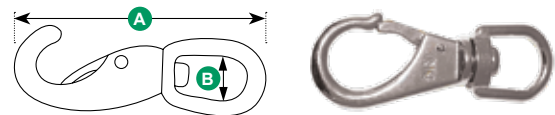

\* SWL (safe working load) is approx 25% of breaking load.

Part No.	Dimensions (mm)		SWL* (kg)
	A	B	
JPW19240	85	18	50
JPW19241	100	20	75
JPW19242	120	20	90

### Fixed Eye Snap Hooks - Stainless Steel

Fixed eye spring snap hook, made from cast 316-grade stainless steel.

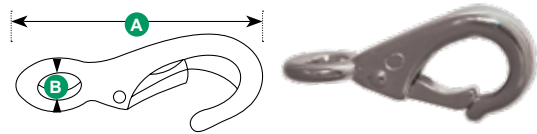

\* SWL (safe working load) is approx 25% of breaking load.

Part No.	Dimensions (mm)		SWL* (kg)
	A	B	
JPW19235	55	10	50
JPW19236	70	16	100
JPW19237	80	20	150

### Cargo Trailer Hooks - Stainless Steel

Cast 316-grade stainless steel with safety latch spring opening.

- Suits light duty lifting or a trailer winch snap hook.

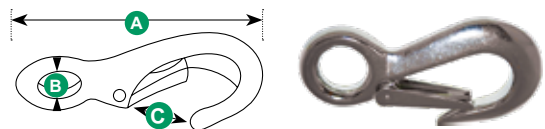

\* SWL (safe working load) is approx 25% of breaking load.

Part No.	Dimensions (mm)			SWL* (kg)
	A	B	C	
JPW19245	100	21	20	188
JPW19246	120	28	22	250

### Snap Hooks Fixed Mount - Stainless Steel

316-grade stainless steel spring loaded snap hook for fixed mounting.

- 2 x 4mm countersunk fastening holes.

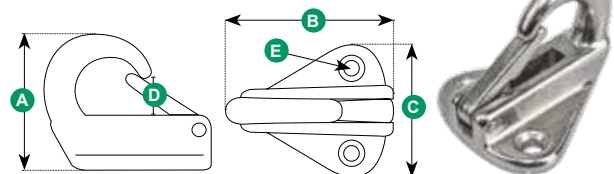

Part No.	Dimensions (mm)				
	A	B	C	D	E
JPW4969	33.5	41	35	10.5	4

**Eye and Eye Turnbuckles - Stainless Steel**

316-grade stainless steel open body eye to eye turnbuckles with lock nuts.

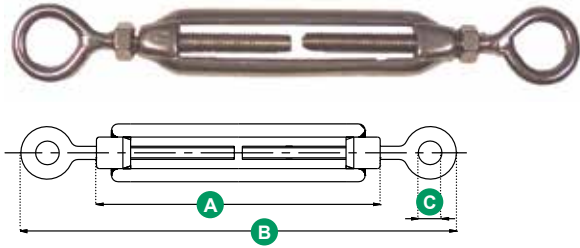

Part No.	Dimensions (mm)			
	Thread	A	B	C
JPW4853	8	90	180	12
JPW4854	10	120	210	12
JPW4855	12	125	220	18

**Eye and Hook Turnbuckles - Stainless Steel**

316-grade stainless steel. Metric thread with lock nuts.

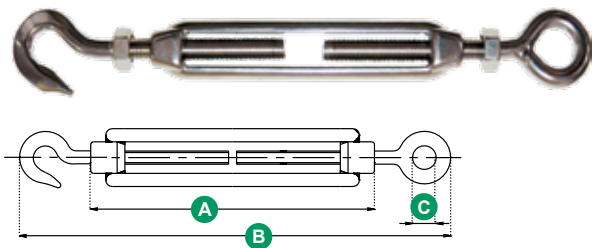

Part No.	Dimensions (mm)			
	Thread	A	B	C
JPW4850	8	125	200	11
JPW4851	10	150	245	15
JPW4852	12	200	320	19

**Collared Head Eye Bolts - Stainless Steel**

Cast 316-grade stainless steel with heavy duty cast eye. Use as a lifting eye bolt, bow eye etc. With metric thread.

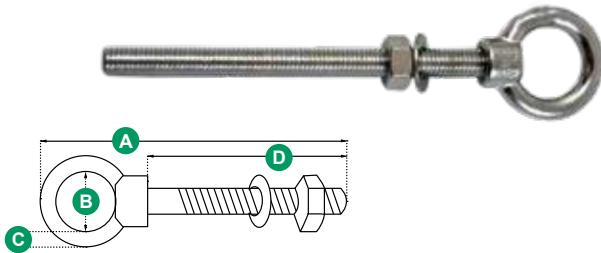

Part No.	Dimensions (mm)				
	Thread	A	B	C	D
JPW4896	6	110	16	5	60
JPW4897	8	135	19	6	100
JPW4898	10	140	25	7	100

**Wire Rope Clamps - Stainless Steel**

Wire rope grips in a range of sizes to suit wire rope diameter from 2mm up to 8mm.

Part No.	Wire Size (mm)
JPW4829	2
JPW4830	3
JPW4832	5
JPW4833	6
JPW4834	8



**U Bolts - Stainless Steel**

316-grade stainless steel 'U' bolts with crimped shaft and metric thread.

- Supplied with 2 cross plates, 2 washers and 2 hex nuts.

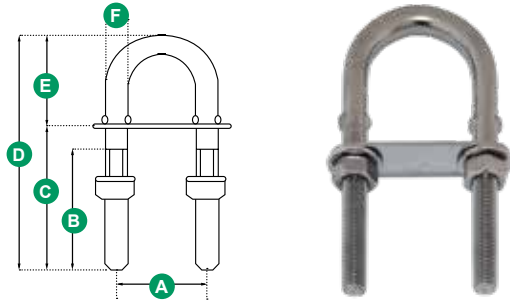

Part No.	Dimensions (mm)					
	Thread	A	B	C	D	E
JPW4864	6	35	40	45	80	30
JPW4865	8	35	40	45	80	35
JPW4866	8	35	48	60	100	40
JPW4867	10	53	55	75	130	55
JPW4868	12	60	60	75	150	75

**U Bolts - Stainless Steel**

316-grade stainless steel 'U' bolts with tapered shaft welded to the bearing plate for added strength.

- Supplied with 2 cross plates and 2 hex nuts.

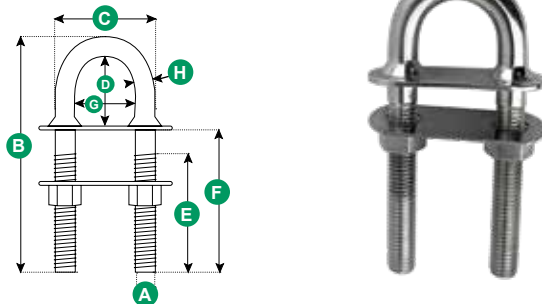

Part No.	Dimensions (mm)							
	Thread (A)	B	C	D	E	F	G	H
JPW4845	9.5 (3/8")	114	45	25.5	66.5	76	25.5	9.5
JPW4846	12.5 (1/2")	110	58	30	54	64	32	12.5
JPW4847	12.5 (1/2")	135	58	30	80	90	32	12.5
JPW4848	12.5 (1/2")	160	58	32	105	115	32	12



### S Hooks - Stainless Steel

'S' Hooks made from 304-grade polished stainless steel.

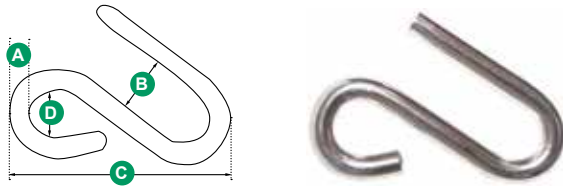

\* SWL (safe working load) is approx 25% of breaking load.

Part No.	Dimensions (mm)				SWL* (kg)
	A	B	C	D	
JPW4801	6	11	60	12	50
JPW4802	8	16	75	16	100
JPW4803	10	18	87	18	163

### Diamond Eye Plates - Stainless Steel

316-grade stainless steel with welded eye.

• 4 x 6mm countersunk fastening holes.

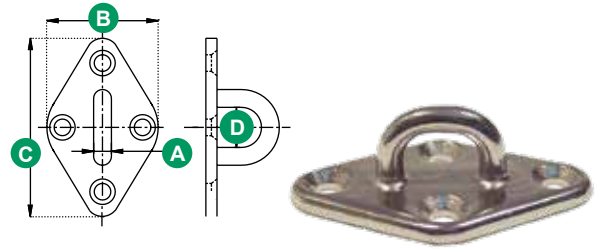

Part No.	Dimensions (mm)			
	A	B	C	D
JPW19208	5	37	59	14
JPW19209	6	43	70	18

### Round Rings - Stainless Steel

Round rings made from 316-grade stainless steel.

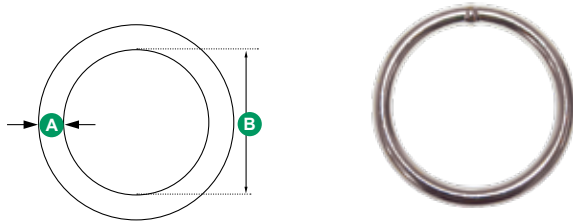

\* SWL (safe working load) is approx 25% of breaking load.

Part No.	Dimensions (mm)		SWL* (kg)
	A	B	
JPW19214	4	25	240
JPW19215	5	40	450
JPW19216	6	40	650
JPW19217	6	50	650
JPW19218	8	50	1100
JPW19219	8	75	1100
JPW19220	10	100	1800
JPW19221	12	120	2400

### Round Eye Plates - Stainless Steel

316-grade stainless steel with welded eye.

• 2 x 5mm countersunk fastening holes.

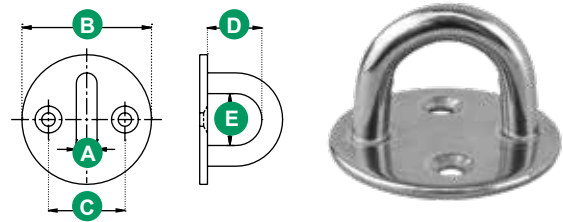

Part No.	Dimensions (mm)				
	A	B	C	D	E
JPW19204	5	33	20	12	14
JPW19205	6	40	23	17	18
JPW19206	8	50	30	21	20

### Dee Rings - Stainless Steel

Dee rings made from 316-grade stainless steel.

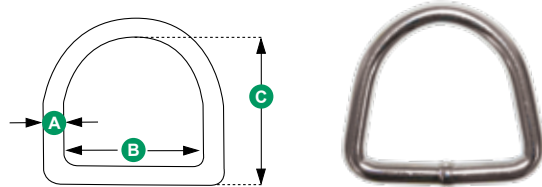

\* SWL (safe working load) is approx 25% of breaking load.

Part No.	Dimensions (mm)			SWL* (kg)
	A	B	C	
JPW19224	4	25	22	200
JPW19225	5	25	22	250
JPW19226	6	40	35	450
JPW19227	6	50	43	450
JPW19228	8	50	43	700

### Rectangle Eye Plates - Stainless Steel

316-grade stainless steel with welded eye.

• 4 x 5mm countersunk fastening holes.

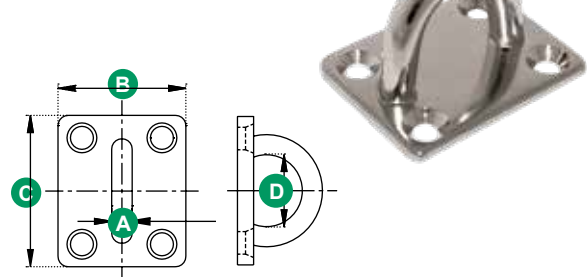

Part No.	Dimensions (mm)			
	A	B	C	D
JPW19200	5	30	35	14
JPW19201	6	35	40	18
JPW19202	8	40	50	20

## Folding Cast Pad Eyes - Stainless Steel

316-grade stainless steel eye plate with welded folding eye.

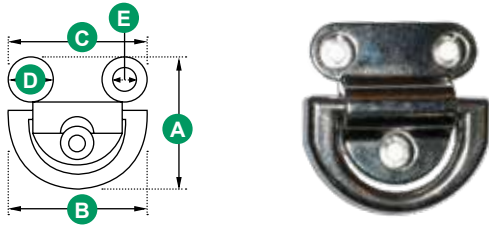

Part No.	Dimensions (mm)				
	A	B	C	D	E
JPW19250	46	45	42	12	6
JPW19251	64	62	57	11	6
JPW19252	78	69	63	11	6

## Double Folding Cast Pad Eye - Stainless Steel

316-grade stainless-steel eye plate with double welded folding eyes.

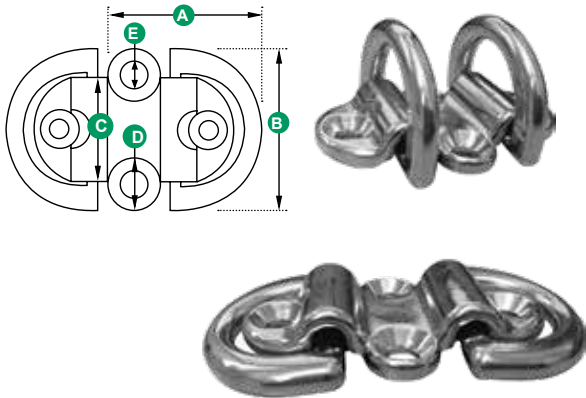

Part No.	Dimensions (mm)				
	A	B	C	D	E
JPW19254	79	45	26	11	6

## Saddle Eye Straps - Stainless Steel

316-grade stainless steel saddle eye strap with countersunk fastening holes.



Part No.	Dimensions L x H (mm)	Fastening Holes (mm)
JPW19166	53 x 17	2 x 4
JPW19167	63 x 20	2 x 5
JPW19168	67 x 53	2 x 6

## Thimbles - Galvanised

Galvanised steel thimbles in a range of sizes (12mm-38mm).

- Traditional style and suitable for splicing into anchor ropes etc.

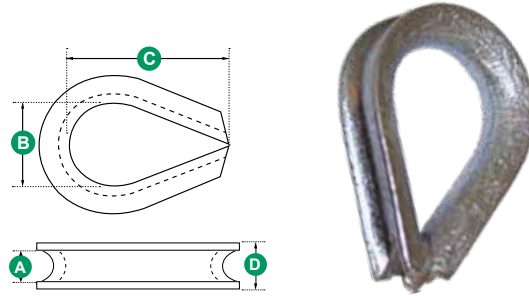

Note: "A" measurement is the diameter of the rope that suits the thimble.

Part No.	Dimensions (mm)			
	A	B	C	D
JPW4000	12	30	70	18
JPW4001	14	40	85	20
JPW4002	16	41	92	22
JPW4004	20	50	115	28
JPW4005	22	52	130	29
JPW4006	24	65	144	32
JPW4008	28	74	168	39
JPW4010	32	96	202	44
JPW4013	38	106	244	52

## Thimbles - Stainless Steel

Traditional rope style thimbles suitable for splicing into small anchor ropes.

- Made with 304-grade stainless steel.

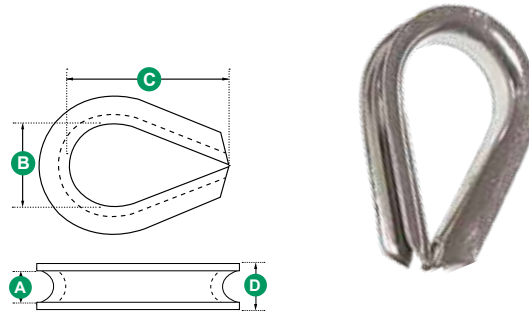

Note: "A" measurement is the diameter of the rope that suits the thimble.

Part No.	Dimensions (mm)			
	A	B	C	D
JPW520	6	13	23	9
JPW521	8	20	34	13
JPW522	10	25	40	15
JPW523	12	28	50	18
JPW525	14	33	53	20
JPW526	16	38	66	23
JPW529	20	47	84	27
JPW531	24	54	85	33

### Shockcord Hooks - Nylon

Black nylon shockcord hooks with spring clip.

Part No.	Suits Shockcord Dia (mm)
JPW13200	5 - 6
JPW13201	7 - 8



### Press Stud Buttons, Eyelets & Sockets



Stainless steel press studs commonly used for canopies and seats.

• Sold in a pack of 10.

Part No.	Type
JPW2876	Button
JPW2879	Socket (Female)
JPW2878	Socket (Male)
JPW2875	Socket with Screw (Male)
JPW2877	Eyelet



### Press Stud & Socket Hand Tool

Hand tool for the easy assembling of press studs/sockets.



Part No.
JPW2874



# HOW TO ORDER

Select products from the catalogue or through our website using the product categories or search function. Make note of the part numbers to facilitate ordering.

## ONLINE



Login to our website  
with your customer username & password.

[www.jpwmarine.com.au](http://www.jpwmarine.com.au)

If you know our product codes, use the  
'Quick Order' form for a speedy checkout.

## PHONE



Call us during standard  
Western Australian business hours on

**(08) 6253 3000**

to place order by phone.

## EMAIL



Email your order to

[orders@jpwmarine.com.au](mailto:orders@jpwmarine.com.au)



# JPW MARINE

WHOLESALE MARINE SPECIALISTS