

# ANODES 07

## ZINC ANODES

Teardrop Anodes .....	7.02
Hull Anodes .....	7.03 - 7.04
Outboard & Stern Drive Motor Anodes.....	7.04
Otter Board Anode .....	7.04
Propeller Shaft .....	7.05
Rudder/Trim Tab Anodes.....	7.05
Engine Anodes .....	7.05
Solid Anodes .....	7.06
General Purpose Anode.....	7.06

## ALUMINIUM ANODES

Mercury/Mercruiser Anode Kits .....	7.07 - 7.08
BRP/Evinrude Johnson Anode Kits .....	7.09
Volvo Penta Anode Kits.....	7.09 - 7.10
Yamaha Anode Kits.....	7.10
Mercury/Mercruiser Anodes .....	7.11 - 7.12
Honda Anodes.....	7.12
BRP/Evinrude Johnson & OMC Anodes .....	7.13
Volvo Penta Anodes .....	7.14
Yamaha Anodes .....	7.15



## ZINC ANODES

Our range of Zinc Anodes are all Australian-made and 'CHERAS' branded. These anodes are manufactured from a high-grade zinc alloy that is 99.9% pure and conforms to Australian Standard AS2239 and U.S Military specs 18001-K.

- Each anode is stamped with its anode code number and weight for easy identification.
- This large range of anodes will suit most marine applications.

### Teardrop Anodes

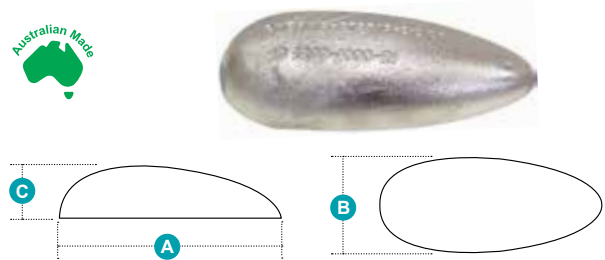

Part No.	Anode Number	Weight (kg)	Dimensions (mm)		
			A	B	C
JPW3099	ZT4	0.4	100	50	25
JPW3098	ZT6	1	150	60	30
JPW3097	ZT7	1.7	180	75	30

### Teardrop Anodes - with Strap

Streamlined teardrop anodes - with either a galvanised steel strap or aluminium strap.

- Galvanised steel strap anodes suit steel hull and fibreglass boats.
- Aluminium strap anodes suit aluminium hull and fibreglass boats.

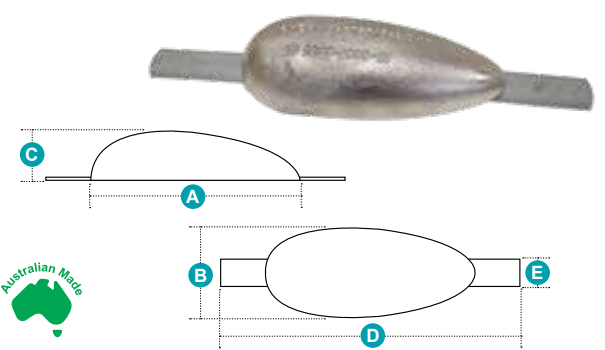

Part No.	Anode Number	Strap Type	Weight (kg)	Dimensions (mm)				
				A	B	C	D	E
JPW3090	ZTS-4	Alloy	0.4	100	50	25	200	25
JPW3090S	ZTS-4	Steel	0.4	100	50	25	200	25
JPW3091	ZTS-5	Alloy	0.8	125	60	30	250	25
JPW3091S	ZTS-5	Steel	0.8	125	60	30	250	25
JPW3092	ZTS-6	Alloy	1	150	60	30	250	25
JPW3092S	ZTS-6	Steel	1	150	60	30	250	25
JPW3093	ZTS-7	Alloy	1.7	180	75	30	300	25
JPW3093S	ZTS-7	Steel	1.7	180	75	30	300	25
JPW3095	ZTS-7/S	Alloy	2.2	175	75	35	300	25
JPW3095S	ZTS-7/S	Steel	2.2	175	75	35	300	25
JPW3094	ZTS-8	Alloy	2.5	250	85	35	330	25
JPW3094S	ZTS-8S	Steel	2.5	250	85	35	330	25

### Hull Slab Anodes

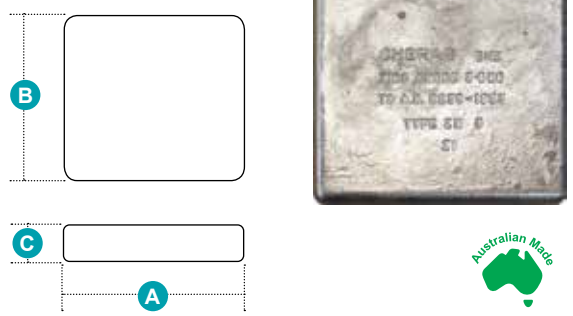

Part No.	Anode Number	Weight (kg)	Dimensions (mm)		
			A	B	C
JPW3130	ZH-1B	1.3	100	75	25
JPW3132	ZH-1	1.6	100	100	25
JPW3134	ZH-2B	1.8	150	75	25
JPW3136	ZH-3	3.6	150	150	25

### Hull Slab Anodes - with Strap

Hull slab anodes available with a galvanised steel or aluminium strap.

- Galvanised steel strap anodes suit steel hull and fibreglass boats.
- Aluminium strap anodes suit aluminium hull and fibreglass boats.

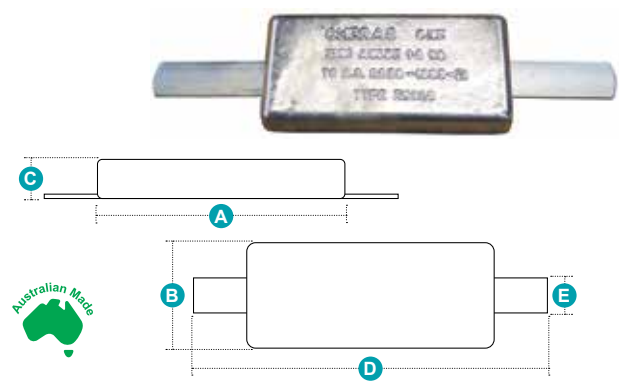

Part No.	Anode Number	Strap Type	Weight (kg)	Dimensions (mm)				
				A	B	C	D	E
JPW3131	ZHS-1B	Alloy	1.2	100	70	25	200	25
JPW3131S	ZHS-1B	Steel	1.2	100	70	25	200	25
JPW3133	ZHS-1	Alloy	1.6	100	100	25	200	25
JPW3133S	ZHS-1	Steel	1.6	100	100	25	200	25
JPW3135	ZHS-2B	Alloy	1.8	150	75	25	300	25
JPW3135S	ZHS-2B	Steel	1.8	150	75	25	300	25
JPW3137	ZHS-3	Alloy	3.6	185	150	25	280	25
JPW3139S	ZHS-4	Steel	4	140	140	25	310	25
JPW3147S	ZHS-5	Steel	5	150	190	30	315	25

### Hull Slab Anode - with Holes

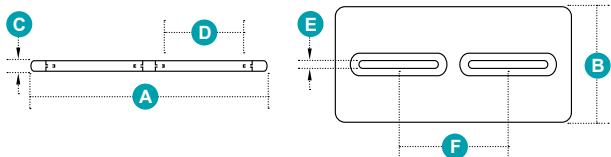

Part No.	Anode Number	Weight (kg)	Dimensions (mm)					
			A	B	C	D	E	F
JPW3129	ZHS-3.5D	3.5	305	150	15	100	8	150

### Hull Oval Anodes

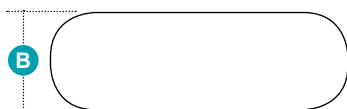
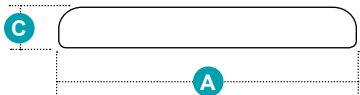

Part No.	Anode Number	Weight (kg)	Dimensions (mm)		
			A	B	C
JPW3141	ZH-6	3.3	270	75	32
JPW3143	ZH-7	6.5	270	150	32

### Hull Oval Anode - with Holes (Sunseeker Style)

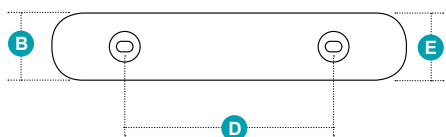

Part No.	Anode Number	Weight (kg)	Dimensions (mm)				
			A	B	C	D	E
JPW3101	ZHS8R	8	440	90	40	234	22x28

### Hull Oval Anodes - with Strap

Large oval anodes available with a galvanised steel or aluminium strap.

- Galvanised steel strap anodes suit steel hull and fibreglass boats.
- Aluminium strap anodes suit aluminium hull and fibreglass boats.

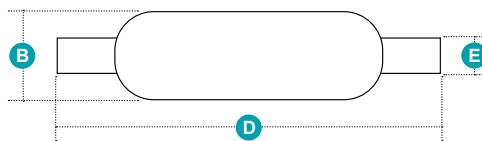
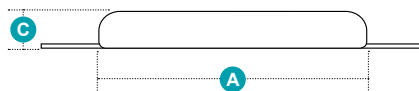

Part No.	Anode Number	Strap Type	Weight (kg)	Dimensions (mm)				
				A	B	C	D	E
JPW3142	ZHS-6	Alloy	3.3	270	75	32	400	40
JPW3142S	ZHS-6	Steel	3.3	270	75	32	400	40
JPW3144	ZHS-7	Alloy	6.5	270	150	32	400	40
JPW3144S	ZHS-7	Steel	6.5	270	150	32	400	40
JPW3148S	ZHS-8	Steel	8	440	80	50	545	40
JPW3145	ZHS-14	Alloy	13.6	304	150	42	440	50
JPW3145S	ZHS-14	Steel	13.6	304	150	42	440	50

### Hull Oval Anode - with Holes

Slotted hull oval anodes with two recessed slotted fixing holes.

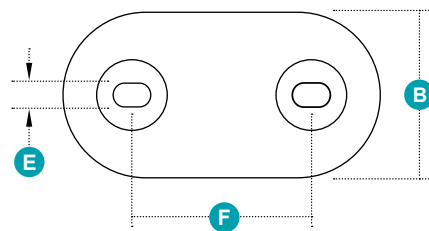
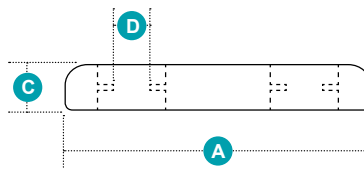

Part No.	Anode Number	Weight (kg)	Dimensions (mm)					
			A	B	C	D	E	F
JPW3140	ZHI-6	6.5	260	145	35	24	16	150

### Hull Oval Anodes - with Steel Strap (Riviera Style)

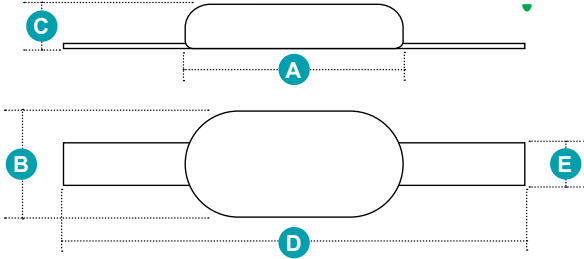

Part No.	Anode Number	Weight (kg)	Dimensions (mm)					
			A	B	C	D	E	F
JPW3100S	ZHS-7	6.5	250	135	30	550	40	150

### Hull Block Anode - with Holes

Slotted rectangular anodes with two recessed slotted fixing holes.

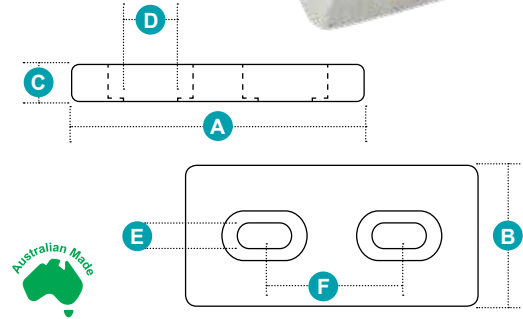

Part No.	Anode Number	Weight (kg)	Dimensions (mm)					
			A	B	C	D	E	F
JPW3138	ZHST	1.5	165	70	25	27	15	80

### Hull Slab Anodes - with Steel Strap (Riviera Style)

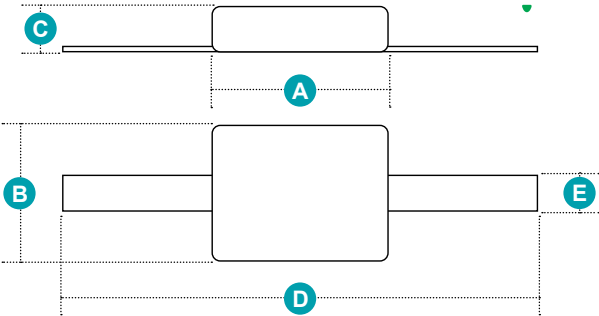

Part No.	Anode Number	Weight (kg)	Dimensions (mm)					
			A	B	C	D	E	F
JPW3102	ZHS-5	5	188	147	25	498	25	150

### Hull Bertram Anode

Bertram hull anodes - for replacement of original O.E.M. anode on Bertram cruisers or a similar craft.

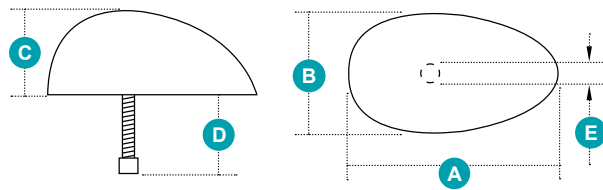

Part No.	Anode Number	Weight (kg)	Dimensions (mm)				
			A	B	C	D	E
JPW3146	ZHB-4	4	160	120	60	65	10

### Outboard and Stern Drive Motor Anodes

Three types available to suit Mercury, Mercruiser and Yamaha engines.



Part No.	Anode Number	Motor	Weight (kg)
JPW3224	ZMO-1	Mercury	0.5
JPW3225	ZMC-2	Mercruiser	0.8
JPW3226	ZYO-1	Yamaha	0.5

### Otter Board Anode

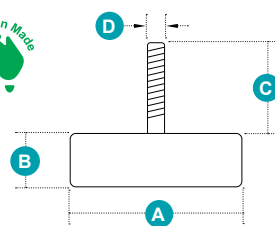

Part No.	Anode Number	Weight (kg)	Dimensions (mm)			
			A	B	C	D
JPW3223	ZD-3	0.7	75	25	40	8

### Propeller Shaft Anodes - Large

Two-piece anodes to fit around the propeller shaft.

- Supplied complete with four large hex head stainless steel bolts and stainless steel nyloc nuts.

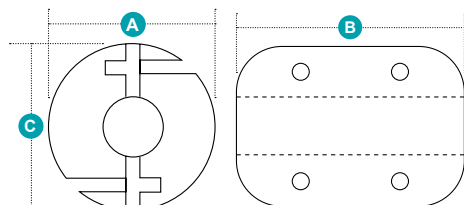

Part No.	Anode Number	Shaft Size		Weight (kg)	Dimensions (mm)		
		(mm)	(in)		A	B	C
JPW3168	ZS-7	51	2	3.9	98	130	95
JPW3169	ZS-8	57	2 1/4	3.6	98	130	95
JPW3170	ZS-9	64	2 1/2	4.8	100	130	98
JPW3171	ZS-10	70	2 3/4	4.2	100	130	98
JPW3172	ZS-11	76	3	5.3	105	150	104
JPW3173	ZS-12	83	3 1/4	8	135	160	135
JPW3174	ZS-14	90	3 1/2	7.6	135	160	135
JPW3175	ZS-16	102	4	9.8	150	175	145

### Rudder/Trim Tab Anodes

Two-piece anodes for mounting on either side of the rudder or trim tabs.

- Supplied with pre-drilled 10mm recessed central holes.
- Without mounting bolts.
- Sold per pair.

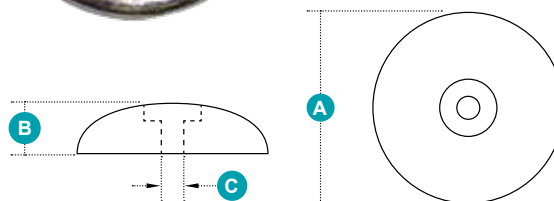

Part No.	Anode Number	Weight (kg)	Dimensions (mm)		
			A	B	C
JPW3220	ZRD-0	0.6	65	19	10
JPW3221	ZRD-1	1.2	100	20	11
JPW3222	ZRD-2	2.3	130	20	11

### Propeller Shaft Anodes

Two-piece anodes to fit around the propeller shaft.

- Supplied with two large Phillips head stainless steel bolts and nyloc nuts.

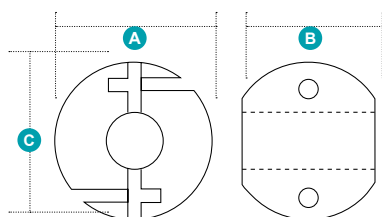

Part No.	Anode Number	Shaft Size		Weight (kg)	Dimensions (mm)		
		(mm)	(in)		A	B	C
JPW3159	ZSA	19	3/4	0.6	51	53	53
JPW3160	ZS-1	22	7/8	0.6	52	53	52
JPW3161	ZS-2	25	1	0.5	56	53	55
JPW3162	ZS-3	29	1 1/8	0.6	61	66	60
JPW3163	ZS-4	32	1 1/4	0.7	63	66	62
JPW3164	ZS-4A	35	1 3/8	1.1	71	78	69
JPW3165	ZS-5	38	1 1/2	1	71	78	69
JPW3166	ZS-6	44	1 3/4	1.2	78	78	76
JPW3167	ZS-6B	51	2	1.3	83	78	82

### Engine Anode - Yanmar

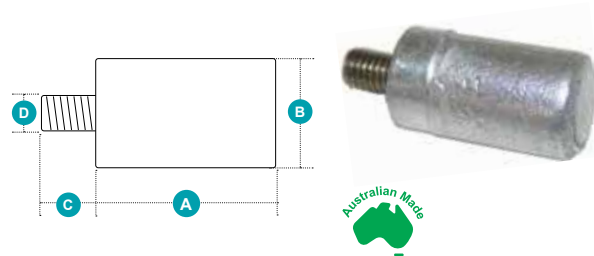

Part No.	Anode Number	Weight (g)	Dimensions (mm)			
			A	B	C	D
JPW3227	ZE-6	0.7	32	18	12	6

### Engine Anode - BUKH

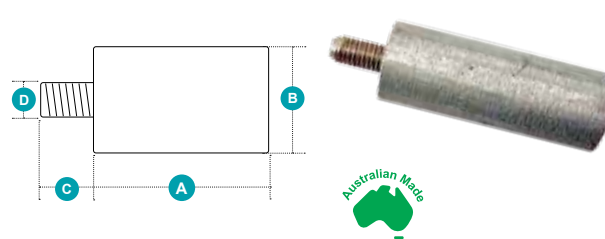

Part No.	Anode Number	Weight (g)	Dimensions (mm)			
			A	B	C	D
JPW3228	ZE-7	40	41	12	12	4

**Solid Square Bar Anode**



Part No.	Anode Number	Weight (kg)	Dimensions (mm) L x W x H
JPW3261	ZB-3	1.4	305 x 25 x 25

**Solid Round Cast Rod Anodes**

Solid round zinc anodes suitable for water jackets, pumps, heat exchangers, and stock material for marine engine anodes.



Part No.	Anode Number	Weight (g)	Dia (mm)	Length (mm)
JPW3252	ZR-1	140	10	300
JPW3253	ZR-2	280	13	300
JPW3254	ZR-3	450	16	300
JPW3255	ZR-4	650	19	300
JPW3256	ZR-5	860	22	300
JPW3257	ZR-6	1000	25	300

**General Purpose Anode**

- Slimline tapered anode - tapers from 13mm to 5mm.
- Can be used on a smaller craft or motor cavitation plates etc.
- 2 x 5mm recessed fastening holes.

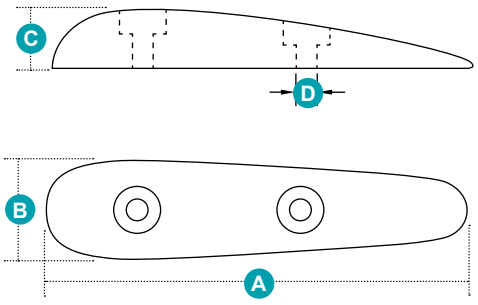

Part No.	Anode Number	Weight (kg)	Dimensions (mm)			
			A	B	C	D
JPW3150	ZGPA	0.2	120	28	13	5



## ALUMINIUM ANODES

- Specially formulated alloy for all water types.
- Red spot wear indicator - when the red spot appears on the surface of the anode, it is time to change it.
- DO NOT mix anode types (aluminium and zinc).
- Aluminium anodes have a higher protection voltage than zinc anodes, lasts up to 30 - 50% longer.
- Reactivate after exposure to air - works immediately on reimmersion.
- Environmentally friendly.
- Much lighter than Zinc.

### Mercury/Mercruiser Anode Kit - Alpha 1 Generation 1 (No Power Steering)

Part No.	Kit Parts	Qty	Weight		Replacement OEM Number
			(lb)	(g)	
JPW3408	Trim Tab Anode	1	0.4	171	31640T 4
	Gimbal Housing Block	1	0.7	317	821631T 1
	Gimbal Housing Bolt Headnut	2	0.15	68	55989T 9



### Mercury/Mercruiser Anode Kit - Alpha 1 Generation 1

Part No.	Kit Parts	Qty	Weight		Replacement OEM Number
			(lb)	(g)	
JPW3430	Trim Tab Anode Flat	1	0.25	110	76214T 5
	Gimbal Housing Block	1	0.7	317	821631T 1
	3/4" Shaft Anodes	2	0.45	200	-



### Mercury/Mercruiser Anode Kit - Alpha 1 Generation 2

Part No.	Replacement OEM	Kit Parts	Qty	Weight		Replacement OEM Number
				(lb)	(g)	
JPW3403	888756A 1	Alpha Cavitation Plate	1	0.55	249	821629T 1
		Alpha Trim Cylinder Anode	2	0.07	31	806189T 1
		Trim Tab Anode Flat	1	0.25	113	76214T 5
		Gimbal Housing Block	1	0.7	317	821631T 1
		Alpha Bearing Carrier	1	0.17	77	806105T 1



**Mercury/Mercruiser Anode Kit - Bravo 1**

Part No.	Replacement OEM	Kit Parts	Qty	Weight		Replacement OEM Number
				(lb)	(g)	
JPW3406	888758A	Bravo Cavitation Plate	1	0.8	363	821630T 1
		Bravo Trim Cylinder Anode	2	0.27	122	806190T 1
		Trim Tab Anode Flat	1	0.25	113	76214T 5
		Bravo Bearing Carrier Anode	1	0.16	72	806188A 1

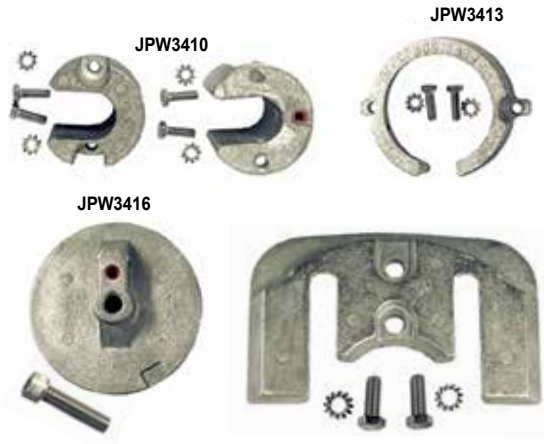

**Mercury/Mercruiser Anode Kit - Bravo 3 (2004+)**

Part No.	Kit Parts	Qty	Weight		Replacement OEM Number
			(lb)	(g)	
JPW3404	Bravo Cavitation Plate	1	0.8	363	821630T 1
	Bravo Trim Cylinder Anode	2	0.27	122	806190T 1
	Trim Tab Anode Flat	1	0.25	113	76214T 5
	Trim Tab Anode Flat (No Thread)	1	0.25	113	76214 4

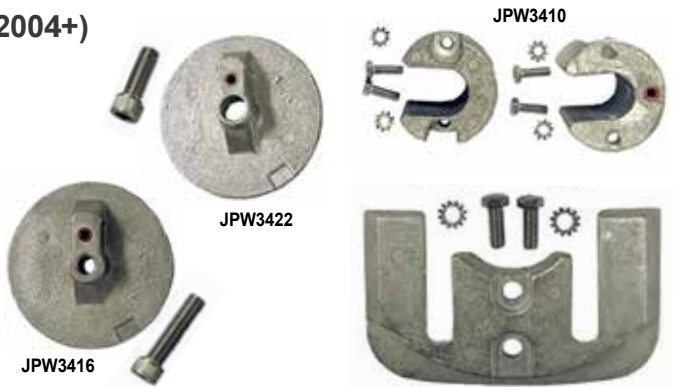

**Bravo Prop Nut Retrofit Anode Kit**

Allows attachment of anode to 2003 and older models.

Part No.	Kit Parts	Qty	Weight	
			(lb)	(g)
JPW3407	Bravo 3 Prop Shaft Anode	1	0.06	27
	Prop Nut	1	0.06	27



**Mercury/Mercruiser Anode Kit - Verado 4**

Part No.	Kit Parts	Qty	Weight		Replacement OEM Number
			(lb)	(g)	
JPW3428	Outboard Power Trim	1	0.5	227	818298T 1
	Side Pocket Anode	2	0.36	163	826134T
	Trim Tab Anode Flat	1	0.25	113	76214T 5

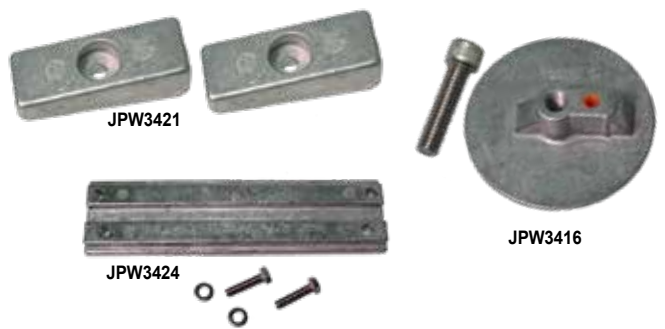

**Mercury/Mercruiser Anode Kit - Verado 6**

Part No.	Kit Parts	Qty	Weight		Replacement OEM Number
			(lb)	(g)	
JPW3405	Trim Tab Anode Flat	1	0.25	113	76214T 5
	Side Pocket Anode	2	0.36	163	826134T
	Manifold Anode	1	0.5	227	880653
	Trim Cylinder Anode	4	0.4	181	893404





**BRP/Evinrude Johnson Anode Kit - OMC Cobra Kit**

Part No.	Kit Parts	Qty	Weight		Replacement OEM Number
			(lb)	(g)	
JPW3429	Prop Shaft	1	0.2	91	431708
	Transom Mount	1	0.7	318	984547
	Front Gear Case Anode	1	0.9	408	3853818/984513
	Cobra Rear Gear Case	1	0.2	91	436745/393023

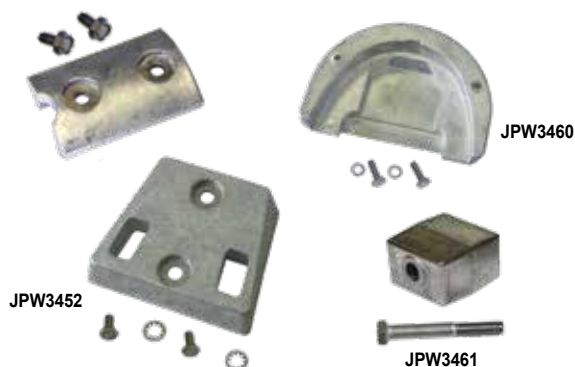

**BRP/Evinrude Johnson Anode Kit - J/E 90-225HP (1985-1986)**

Part No.	Kit Parts	Qty	Weight		Replacement OEM Number
			(lb)	(g)	
JPW3431	Side Mounted	1	2.2	998	s123009/327606/173029
	Front Gear Case	1	0.7	318	s 392123

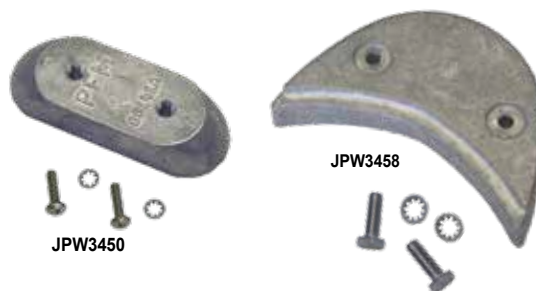

**Volvo Penta Anode Kit - Volvo 280 Dual Prop**

Part No.	Kit Parts	Qty	Weight		Replacement OEM Number
			(lb)	(g)	
JPW3434	Anodic Bar	1	0.7	318	852835
	Prop Ring - Duo Prop (US)	1	0.5	227	875821

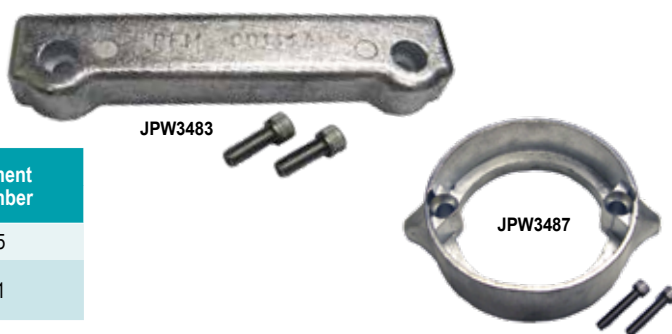

**Volvo Penta Anode Kit - Volvo 290**

Part No.	Kit Parts	Qty	Weight		Replacement OEM Number
			(lb)	(g)	
JPW3425	Prop Ring - V18	1	0.6	272	875815
	Anodic Bar	1	0.8	363	832598



**Volvo Penta Anode Export Kit - Volvo 290 Export**

Part No.	Kit Parts	Qty	Weight		Replacement OEM Number
			(lb)	(g)	
JPW3435	Prop Ring - V18	1	0.6	272	875815
	Side Mounted Anode - SX, DP-X	2	0.1	45	872793
	Anodic Bar	1	0.7	318	852835



**Volvo Penta Anode Export Kit -  
Volvo 290 Dual Prop Export**

Part No.	Kit Parts	Qty	Weight		Replacement OEM Number
			(lb)	(g)	
JPW3426	Anodic Bar	1	0.7	317	852835
	Side Mounted Anode - SX, DP-X	2	0.1	45	872793
	Prop Ring - Duo Prop (Export Use)	1	0.5	226	875821



**Yamaha Anode Kit -  
200-250HP 4-Stroke**

Part No.	Kit Parts	Qty	Weight		Replacement OEM Number
			(lb)	(g)	
JPW3427	Transom Anode	1	0.8	363	6G5-45251-02
	Trim Tab 150, 175HP (Counter Rotating)	1	0.6	272	6K1-45371-02



**Yamaha Anode Kit -  
150-200HP**

Part No.	Kit Parts	Qty	Weight		Replacement OEM Number
			(lb)	(g)	
JPW3438	Transom Anode	1	0.8	363	6G5-45251-02
	Trim Tab 150, 175HP	1	0.6	272	6J9-45371-01











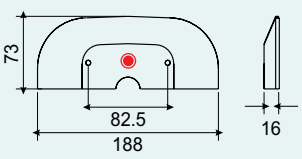

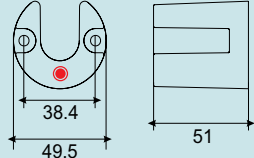

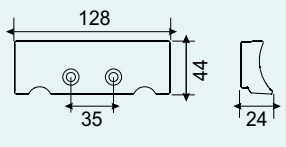

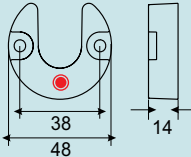

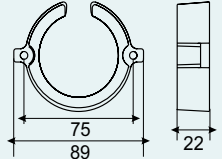
**Yamaha Anode Kit -  
60-90HP**

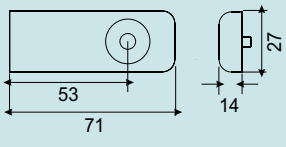

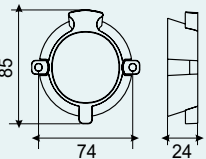
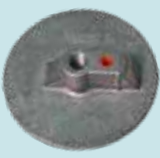
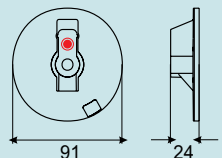

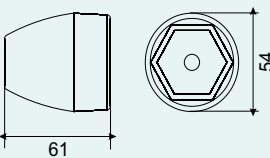
Part No.	Kit Parts	Qty	Weight		Replacement OEM Number
			(lb)	(g)	
JPW3439	Transom Anode	1	0.45	204	6H1-45251-02
	Trim Tab 60-90HP	1	0.4	181	688-45371-02

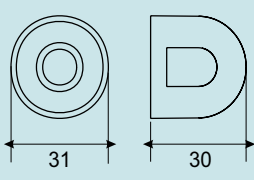



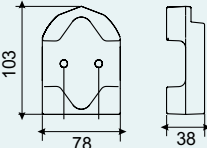

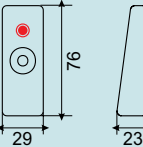
## Mercury/Mercruiser Aluminium Anodes

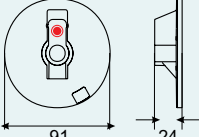
Part No.	Image	Dimensions	Anode Type	Weight (g)	Replacement OEM No.
JPW3409			Alpha Cavitation Plate	240	821629T 1
JPW3410			Bravo Trim Cylinder	120	806190T 1
JPW3411			Manifold Anode	210	880653
JPW3412			Alpha Trim Cylinder	30	806189T 1
JPW3413			Bravo Bearing Carrier	70	806188A 1
JPW3414			Trim Cylinder Anode	40	893404
JPW3415			Alpha Bearing Carrier	80	806105T 1
JPW3416			Trim Tab Anode Flat	100	76214T 5
JPW3417			Bravo 3 Prop Anode	180	865182A 1
JPW3418			Gimbal Housing Bolt	70	55989T 9



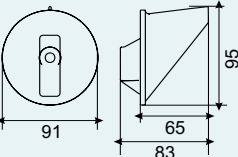

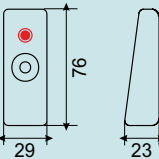

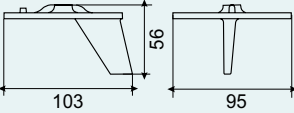



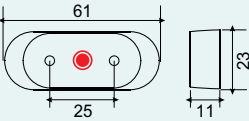

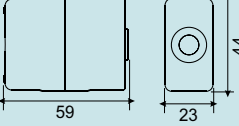
Mercury/Mercruiser Aluminium Anodes *continued*

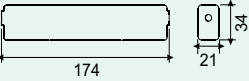
Part No.	Image	Dimensions	Anode Type	Weight (g)	Replacement OEM No.
JPW3420			Gimbal Housing Block	300	821631T 1
JPW3421			Side Pocket Anode	80	826134T
JPW3422			Trim Tab Anode Flat (No Thread)	100	76214-4

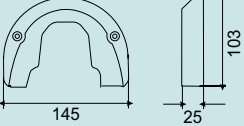

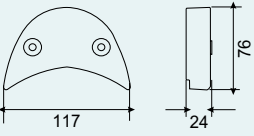

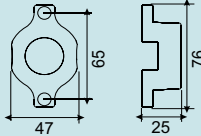

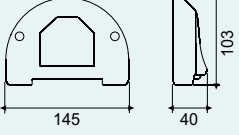

Honda Aluminium Anodes

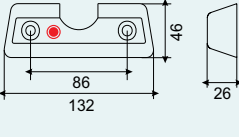
Part No.	Image	Dimensions	Anode Type	Weight (g)	Replacement OEM No.
JPW3401			Trim Tab Anode	170	41107-ZW1-003ZA
JPW3421			Side Pocket Anode	80	41109-ZW1-003
JPW3402			Trim Tab	120	41107-ZV5-000

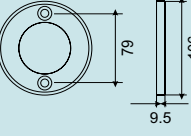

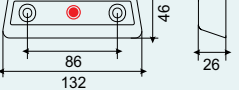

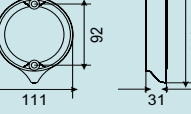
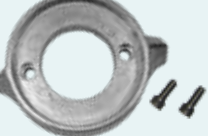
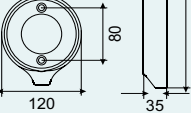

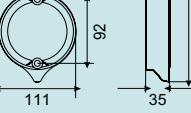



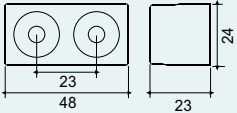

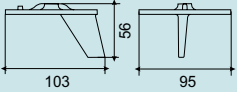
## BRP/Evinrude Johnson and OMC Aluminium Anodes

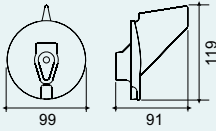
Part No.	Image	Dimensions	Anode Type	Weight (g)	Replacement OEM No.
JPW3450			Side Mounted	50	123009 327606 173029
JPW3455			Rear Gear Case	150	433458 398331
JPW3456			Transom Bar	300	433580
JPW3457			Horse Shoe	280	983494
JPW3458			Outboard Anode	300	392123
JPW3459			Outboard Anode	300	398873
JPW3460			Cobra Anode	400	3853818 984513

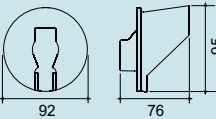
### Volvo Penta Aluminium Anodes

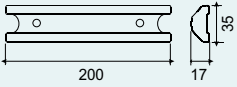
Part No.	Image	Dimensions	Anode Type	Weight (g)	Replacement OEM No.
JPW3482			Anodic Bar	250	872139
JPW3484			Prop Ring (V16)	70	875810-4
JPW3486			Anodic Bar	300	852835-8
JPW3487			Prop Ring (Duo Prop)	230	875821-1
JPW3488			Prop Ring (V18)	260	875815
JPW3492			Prop Ring - Duo Prop (Exp)	230	875821

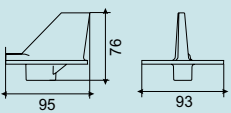
## Yamaha Aluminium Anodes

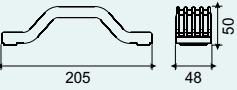
Part No.	Image	Dimensions	Anode Type	Weight (g)	Replacement OEM No.
JPW3494			Block	70	6E5-45251-00
JPW3402			Trim Tab 20 - 50HP	120	664-45371-01
JPW3498			Trim Tab 200 - 250HP 4 Stroke	300	61A-45371-00
JPW3499			Trim Tab 115 - 130HP	200	6E5-45371-01
JPW3500			Transom Bar Anode	200	6H1-45251-02
JPW3502 JPW3502-Z (Zinc Version)			Trim Tab C. Rot	200	6K1-45371-00
JPW3503			Transom Anode	400	6G5-45251-02

# HOW TO ORDER

Select products from the catalogue or through our website using the product categories or search function. Make note of the part numbers to facilitate ordering.

## ONLINE



Login to our website  
with your customer username & password.

[www.jpwmarine.com.au](http://www.jpwmarine.com.au)

If you know our product codes, use the  
'Quick Order' form for a speedy checkout.

## PHONE



Call us during standard  
Western Australian business hours on

**(08) 6253 3000**

to place order by phone.

## EMAIL

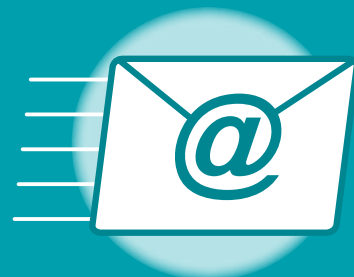

Email your order to

[orders@jpwmarine.com.au](mailto:orders@jpwmarine.com.au)



# JPW MARINE

WHOLESALE MARINE SPECIALISTS