

# HULL, DECK & CABIN HARDWARE 04

## CABIN HARDWARE

Hinges .....	4.02
Latches and Fasteners.....	4.03 - 4.04
Barrel Bolts.....	4.03
Ring-Pulls .....	4.04
Cupboard & Door Catches .....	4.05
Vents .....	4.05
Drink Holders .....	4.06 - 4.07
Saddle Eye Straps .....	4.07
Grab Handle & Rails .....	4.07 - 4.08
Storage Cases .....	4.08
Glove Boxes.....	4.09
Hatch Door, Handle & Pulls.....	4.09

## HULL & DECK HARDWARE

Instrument Mounts .....	4.10
Phone Mounts .....	4.10
Tablet Mount Kits.....	4.10
Bow Rollers .....	4.11 - 4.12
Bollards .....	4.13
Fairleads .....	4.13
Cleats .....	4.14 - 4.15
Lifting Ring.....	4.15
Scuppers .....	4.16
Brackets for Live Bait Tanks.....	4.16
Fuel Breathers.....	4.17
Deck Fillers.....	4.17 - 4.18
Inspection Ports .....	4.19
Deck Plates .....	4.20
Bungs & Bases.....	4.20 - 4.23
Hawse Pipes .....	4.21
Trim Rings & Slop Stoppers.....	4.21
Canopy Fittings .....	4.24 - 4.26
Rail Fittings .....	4.27
Flag Pole & Antenna Bases .....	4.28
Boat Rego Numbers and Letters .....	4.29
Telescopic Ladders .....	4.30 - 4.32
Folding Step .....	4.33
Transducer Brackets & Covers .....	4.33
Davits .....	4.33
StopGull Air Seagull Deterrents .....	4.34 - 4.35
Radar Deck & Mast Mounts .....	4.36 - 4.37



**Cast Stainless Steel Concealed Hinge with Stud**

316-grade smooth polished stainless steel with M6 fixing studs.

Part No.	Dimensions L x W (mm)	Fixing Studs
JPW19178	94 x 49	M6
JPW19179	76 x 40	M6



**Square Butt Hinges - Cast Stainless Steel**

- Cast 316-grade heavy duty stainless steel.
- Sold individually.
- Four 5mm countersunk fastening holes.

Part No.	Dimensions L x W (mm)
JPW19082	38 x 38
JPW19112	50 x 50



**Cast Stainless Steel Concealed Door Hinge with Stud**

316-grade smooth polished stainless steel with M6 fixing studs.

Part No.	Dimensions L x W (mm)	Fixing Studs
JPW19187	70 x 40mm	M6
JPW19188	72 x 65mm	M6
JPW19189	83 x 65mm	M6



**Door Hinges - Cast Stainless Steel**

- Cast 316-grade heavy duty stainless steel.
- 3mm thick and highly polished.
- Sold individually.
- Five 5mm countersunk fastening holes.

Part No.	Dimensions L x W (mm)
JPW19083	56 x 38
JPW19115	76 x 38



**Cast Stainless Steel External Hinge with Stud**

316-grade smooth polished stainless steel with M6 fixing studs.

Part No.	Dimensions L x W (mm)	Fixing Studs
JPW19191	84 x 45	M6
JPW19192	69 x 35	M6



**10mm Offset Hinges - Cast Stainless Steel**

- Cast 316-grade heavy duty stainless steel.
- Sold individually.
- Five 5mm countersunk fastening holes.

Part No.	Dimensions L x W (mm)
JPW19113	57 x 38
JPW19114	70 x 38



**Cast Hinges - Stainless Steel**

- 316-grade heavy duty stainless steel.
- Sold individually.
- 5mm countersunk fastening holes.

Part No.	Dimensions L x W (mm)	Fastening Holes
JPW19080	98 x 23	4 x 5mm
JPW19081	160 x 27	6 x 5mm



**Separating Hinge - Stainless Steel**

- Cast 316-grade heavy duty stainless steel take apart hinge.
- Sold individually.
- Four 5mm countersunk fastening holes.

Part No.	Type	Dimensions L x W (mm)
JPW19084	Right	90 x 38
JPW19085	Left	90 x 38



**Cast Hinges - Stainless Steel**

- 316-grade heavy duty stainless steel.
- Sold individually.
- 5mm countersunk fastening holes.

Part No.	Dimensions L x W (mm)	Fastening Holes
JPW19078	76 x 38	6 x 5mm
JPW19079	102 x 38	6 x 5mm



**Separating Hatch Hinges - Stainless Steel**

- Cast 316-grade stainless steel with an in-built stopper to hold the hinge upright.
- Has a removable pin to separate.
- Sold individually.
- 5mm countersunk fastening holes.

Part No.	Type	Dimensions L x W (mm)
JPW19117	Straight	75 x 56
JPW19118	Angled	82 x 76



### Toggle Adjustable Hatch Latches - Stainless Steel

Adjustable toggle latch 316-grade stainless steel with cam action lever. Length adjusts by turning threaded bolt.

- 5mm countersunk mounting holes.

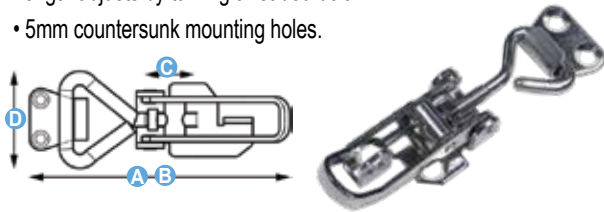

Part No.	Dimensions (mm)			
	A (max)	B (min)	C	D
JPW4700	75	65	10	26
JPW4703	95	85	10	26
JPW4701	125	115	15	36

### Anti-Rattle Hatch Fastener - Stainless Steel

Lever action, silent anti-rattle type with an eye for a padlock. Heavy duty cast 316-grade stainless steel.

- 5mm countersunk fastening holes.

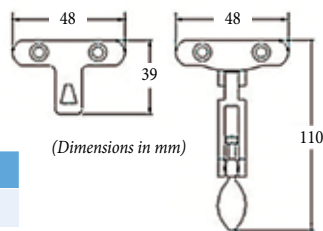

Part No.
JPW4705

### Hatch Fastener Eye Lock Cast 316-Grade Stainless Steel

Cast 316-grade stainless steel hatch fastener flat mounting with eye for a padlock.

- Bolt down area size: 70 x 29mm.
- 4mm countersunk fastening holes.



Part No.	Dimensions L x W (mm)
JPW4707	90 x 29

### Heavy Duty Swivel Latch - Stainless Steel

Heavy duty, highly polished 316-grade stainless steel door latch with spring loaded locking pin to secure in place.

- Long thick handle swivels 360 degrees.
- Four 6mm countersunk fastening holes.

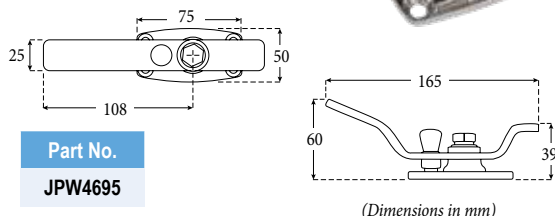

Part No.
JPW4695

### Hasp and Staple Swivel Lock Latches - Stainless Steel

Very heavy duty cast 316-grade stainless steel with highly polished finish.

- Rotatable staple to lock hasp in place.
- Suitable for padlocks up to 8mm.
- 5mm countersunk fastening holes.



Part No.	Dimensions L x W (mm)
JPW4698	76 x 25

### Hasp and Staple Latches - Stainless Steel

Pressed 316-grade stainless steel hasp and staple latches with rotatable staple to lock the hasp in place or standard fixed eye.

- Suitable for padlocks up to 8mm.
- 5mm countersunk fastening holes.



Part No.	Type	Dimensions L x W (mm)
JPW4702	Swivel Lock	70 x 25
JPW4704	Fixed Eye	70 x 25

### Locking Hasp Latch - Stainless Steel

304-grade stainless steel with lockable hasp.

- 29 x 41mm base area behind lock.
- Seven 4mm countersunk fastening holes.

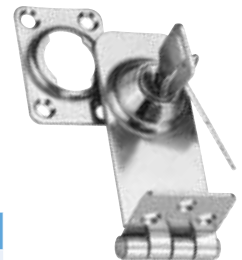

Part No.	Dimensions L x W (mm)
JPW4697	76 x 30

### Barrel Bolts - Stainless Steel

Highly polished heavy duty cast 316-grade stainless steel barrel bolts.

- 5mm countersunk fastening holes.



Part No.	Dimensions L x W (mm)
JPW4691	90 x 38
JPW4693	108 x 38

### Barrel Spring Bolt - Black Nylon

Non-corrosive nylon spring-loaded barrel bolt.

- Ideal for marine applications.

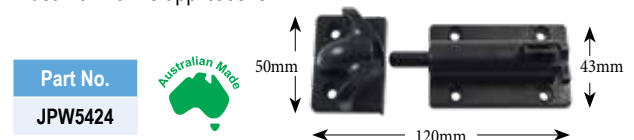

Part No.
JPW5424

**Flush Hatch Latches - Stainless Steel**

Heavy duty 316-grade stainless steel hatch latch pull handle.

- The locking arm is height adjustable.

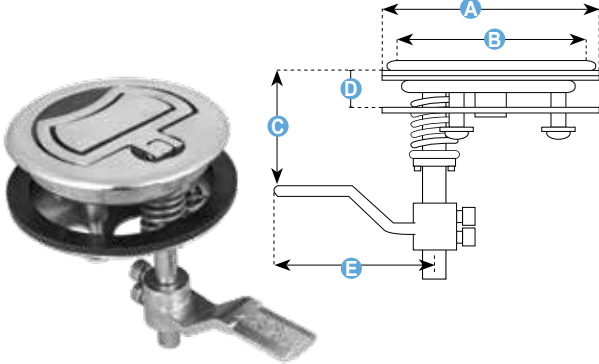

Part No.	Dimensions (mm)				
	A Ø	B Ø	C	D	E
JPW19048	60	50	37 - 70	15 - 25	74
JPW19049	90	76	37 - 70	8 - 30	74

**Cast Stainless Steel Hatch Ring-Pull**

316-grade heavy duty stainless steel hatch latch pull handle. The locking arm is height adjustable and secured with a stainless steel set screw.

- Set the height adjuster between 30-100mm.
- 5mm countersunk fastening holes.

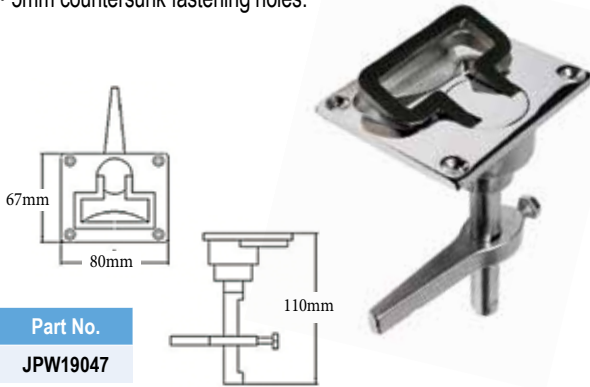

Part No.
JPW19047

**Flush Slam Latch - Stainless Steel**

Cast 316-grade stainless steel flush mounting, low profile and self-latching; ideal for galley doors and drawers. Lift ring with spring return and 1mm spacer ring.

- Door Thickness: 11-20mm.
- 50mm cut-out diameter.

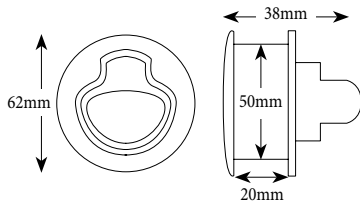

Part No.
JPW4708

**Cast Stainless Steel Ring-Pull with Spring Return**

Flush pull with spring, cast from 316-grade stainless steel.

- 5mm countersunk fastening holes.
- Depth: 11mm

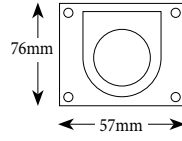

Part No.
JPW19062

**Cast Stainless Steel Flush Ring-Pull - Round**

316-marine grade stainless steel for long-life performance and durability.

- 5mm countersunk fastening holes.
- Overall depth: 11mm



Part No.	Diameter (mm)
JPW19063	50

**Cast Stainless Steel Ring-Pull**

Flush mount ring-pull made from 316-grade stainless steel.

- 5mm countersunk fastening holes.
- Depth: 12mm

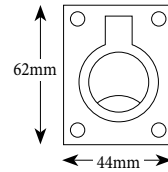

Part No.
JPW19064

**Stainless Steel Ring-Pull**

Flush mount ring-pull made from 316-grade stainless steel.

- 5mm countersunk fastening holes.
- Depth: 12mm

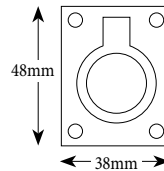

Part No.
JPW19070

**Cast Stainless Steel Ring-Pull - Heavy Duty**

Heavy duty cast 316-grade stainless steel flush mount ring-pull.

- 5mm countersunk fastening holes.
- Depth: 9mm

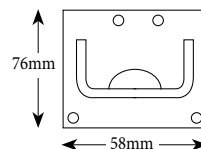

Part No.
JPW19071

### Cupboard Catch - White Nylon

Made from impact-resistant UV-stabilised plastic.



Part No.	Catch Base H x W (mm)	Post Base L x W (mm)
JPW5493	27 x 20	24 x 28

### Magnetic Door Catch - Stainless Steel

Extremely strong magnet holds door from swinging.

- Cast 316-grade stainless steel.
- Rubber cover for soft close.



Part No.	Catch Base L x W (mm)	Ball Base L x W (mm)
JPW4687	45 x 26	34 x 18

### Blower Vents - ABS Plastic

Louvre ventilators made from ABS plastic with a hose tail end for connection to 75mm bilge blower exhaust outlet hose.

- Four 8mm countersunk fastening holes.



Part No.	Colour	Dimensions L x W x H (mm)
JPW1237	White	90 x 90 x 50
JPW1238	Black	90 x 90 x 50

### Flush Mount Vents - Nylon

ABS plastic flush mount louvre vents.

- Suitable for lockers, doors, cupboards, etc.
- Four 8mm countersunk fastening holes.



Part No.	Colour	Dimensions L x W (mm)
JPW1239	White	85 x 85
JPW1240	Black	85 x 85

### Mini Clam Vents - Stainless Steel

Commonly used as anchor well drain covers or for covering thru-transom wiring connections.

- Pressed 316-grade stainless steel.



Part No.	Dimensions L x W x H (mm)	Fastening Holes (mm)
JPW1245	43 x 42 x 10	3 x 3
JPW1246	57 x 55 x 13	3 x 3.75

### 6 Louvre Vents - ABS Plastic

Strong UV-stabilised ABS plastic vents with rounded corners.

- Six 5mm countersunk fastening holes.



Part No.	Colour	Dimensions L x H (mm)
JPW1230	Black	260 x 125
JPW1231	White	260 x 125

### Louvre Vents with Serration - Nylon

UV-resistant nylon with a serration across the centre so it can be made into two smaller vents.

- Two 6 louvres per vent.
- Twelve 8mm countersunk fastening holes.



Part No.	Colour	Dimensions L x H (mm)
JPW1235	White	256 x 118
JPW1236	Black	256 x 118

### Louvre Vents - Stainless Steel

Made from pressed 316-grade stainless steel with a mirror-polished surface and low-profile design for a slimline look.

- 1mm thick plate.



Part No.	No. Louvres	Dimensions L x W (mm)	Fastening Holes
JPW1241	3	127 x 65	6 x 4mm
JPW1242	14	127 x 227	12 x 4.5mm
JPW1243	12	232 x 115	10 x 4mm
JPW1244	6	127 x 115	6 x 4mm

### Louvre Vents - Stainless Steel

Durable V-style or flat style louvre vents.



Part No.	No. Louvres	Dimensions L x W (mm)	Stainless Steel Grade
JPW1248	4	265 x 112 x 26	304-grade
JPW1249	5	327 x 112 x 26	304-grade
JPW1254	10	527 x 76 x 26	316-grade



**Recessed Drink Holder - Plastic**

Black plastic large recessed drink holder  
 • Moulded drain outlet to suit 10mm hose.



Part No.	O.D (mm)	I.D. (mm)	Cut-Out (mm)	Height (mm)
JPW3867	110	90	92	83

**Drink Holder with Drain - Polished Stainless Steel**

Polished 316-grade stainless steel drink holder with moulded drain hose barb and rubber base insert.  
 • Drain hole barb connection for 6.5mm hose.  
 • Packaged for pegboard display.



Part No.	O.D (mm)	I.D. (mm)	Cut-Out (mm)	Height (mm)
JPW3862	108	90	92	83

**Drink Holder with Drain - Brushed Stainless Steel**

Brushed 316-grade stainless steel drink holder with drain hole and rubber base insert.  
 • Includes a foam seal with double sided tape under top lip for easy installation.



Part No.	O.D (mm)	I.D. (mm)	Cut-Out (mm)	Height (mm)
JPW3868	108	90	92	83

**Drink Holder Large Twin Size Carbon Print with Drain**

Plastic drink holder with carbon print and stepped base to hold a variety of sized drink containers.  
 • Removable rubber plugged drain with moulded outlet to suit 10mm hose.



Part No.	O.D (mm)	I.D. (mm)	Cut-Out (mm)	Height (mm)
JPW3872	108	88	92	86

**Drink Holder with Blue LED Lights and Drain - Stainless Steel**

Brushed finish stainless steel with in-built blue LED lights, rubber base insert and drain.



Part No.	O.D (mm)	I.D. (mm)	Cut-Out (mm)	Height (mm)
JPW3871	108	90	92	83

**Folding Drink Holders Adjustable with Extendable Arms**

Made from sturdy ABS plastic. Mounts easily to any vertical surface and folds up near flat after use - protrudes only 23mm when folded.  
 • Adjustable arms extended 75mm to 165mm.  
 • Four 5mm countersunk fastening holes.



JPW3863

Part No.	Colour	Dimensions L x W (mm)
JPW3863	White	95 x 97
JPW3864	Black	95 x 97



JPW3864  
Folded Flat

**Folding Drink Holders Adjustable with Flip-up Ring**

Mounts easily to any vertical surface and folds up near flat after use - protrudes only 23mm when folded.  
 • Made from sturdy ABS plastic.  
 • Three 5mm countersunk fastening holes.



JPW3865

Part No.	Colour	Dimensions L x W (mm)
JPW3865	White	105 x 115
JPW3866	Black	105 x 115



JPW3866  
Folded Flat

**Folding Drink Holder - Stainless Steel**

Stainless steel folding drink holder with adjustable arm grips.  
 • Foam coaster on base.  
 • Black PVC mouldings and retainers.  
 • Protrudes out 21mm when closed.



Folded Flat

Part No.	Dimensions L x W (mm)
JPW3869	102 x 98

**Folding Rail Mount Drink Holder - Stainless Steel**

316-grade stainless steel folding drink holder with an adjustable arm grips. The rail mount bracket can rotate 360° and will suit horizontal or vertical rails (25mm diameter).  
 • Foam coaster on base.  
 • Black PVC mouldings and retainers.



Folded Flat

Part No.	Dimensions L x W (mm)
JPW3873	105 x 97

### Side Mount Ring Drink Holder - Stainless Steel

Stylish ring drink holder made from polished 316-grade stainless steel.

- Side mount plate with two 5mm countersunk fastening holes.



Part No.	Height (mm)	Width (mm)	Ring I.D. (mm)
JPW3858	110	130	90

### Grab Handle - Black Nylon

Non-corrosive nylon grab handle with two 5mm countersunk fastening holes.



Part No.	Dimensions L x H (mm)
JPW5425	145 x 25 x 40

### Single and Double Ring Drink Holders - Stainless Steel

Stylish ring drink holders made from polished 316-grade stainless steel.

- Surface mount - fastens from below with 1/4" thread (screws and washers not included).



Part No.	Type	Height (mm)	Width (mm)	Ring I.D. (mm)
JPW3860	Single	70	105	90
JPW3861	Double	70	210	90

### Grab Handle Stainless Steel

Heavy duty cast 316-grade stainless steel with four 5mm countersunk fastening holes.



Part No.	Dimensions L x H (mm)
JPW4725	150 x 50

### STILLA Multifunctional Cup Bottle Holder with Spike

A spill proof cup & bottle holder solution, ideal for securing wine glasses, soda cans, cups, glasses, and more. Mount into cup holders or on top of table posts, or use the included spike to place into the ground.

- Made from 60% recycled fishing ropes, trawls and nets.
- Accommodates up to 5 containers.
- Dishwasher safe



Part No.	Dia x H (mm)
JPW10321	259 x 180

### Stud Mount Hand Rails - Stainless Steel

Polished 316-grade stainless steel hand rail with flange and 8mm BSW studs.

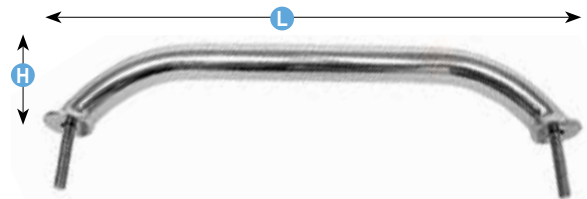

Part No.	Dimensions L x H (mm)
JPW4730	250 x 60
JPW4731	335 x 60
JPW4732	440 x 60
JPW4733	490 x 60

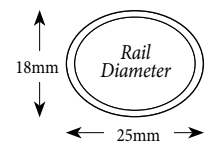

### Stud Mount Hand Rails - Stainless Steel

Polished 304-grade stainless steel hand rail with non-flanged 6mm studs.

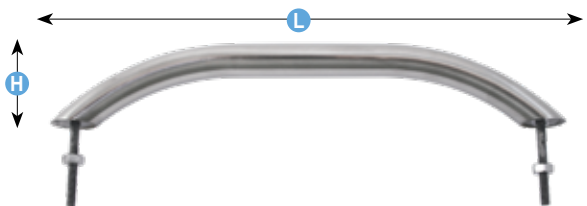

Part No.	Dimensions L x H (mm)
JPW4735	300 x 50
JPW4736	450 x 50
JPW4737	600 x 50

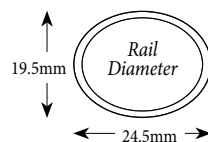

### Saddle Eye Straps - Stainless Steel

316-grade stainless steel saddle eye strap with countersunk fastening holes.



Part No.	Dimensions L x H (mm)	Fastening Holes (mm)
JPW19166	53 x 17	2 x 4
JPW19167	63 x 20	2 x 5
JPW19168	67 x 53	2 x 6

### Slimline Stainless Steel Towel Rail

Add to fibreglass bait boards or install in any other required location.



Part No.	Overall (mm)	Rail (mm)	Screw (mm)
JPW12883	487	12	6

### Stud Mount Hand Rail - Stainless Steel



Polished 316-grade stainless steel hand rail supplied with heavy duty stainless steel washers and nyloc bolts.



Part No.	Length (mm)
JPW4738	900

### Stud Mount Hand Rail with Support Leg - Stainless Steel



Polished 316-grade stainless steel hand rail supplied with heavy duty stainless steel washers and nyloc bolts.

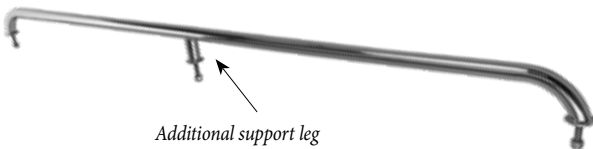

Part No.	Length (mm)
JPW4739	1455

### Narva Hand Rail Chrome Polished with LED Light



Fully sealed, water resistant premium hand rail with LED light provides effective illumination matched with sophisticated styling.

**Current Draw:** 0.13A @ 12V  
**Voltage:** 12V  
**Colour Temp:** 5700°K



Part No.	Dimensions L x W x H (mm)
N87605	330 x 70 x 45

### Storage Cases - White ABS Plastic

A range of white ABS plastic recessed boxes ideal for use as recessed storage pockets in a dry or covered area.

- Can be used for storage, transom shower holders, battery isolator enclosure and a variety of other uses.



JPW1259

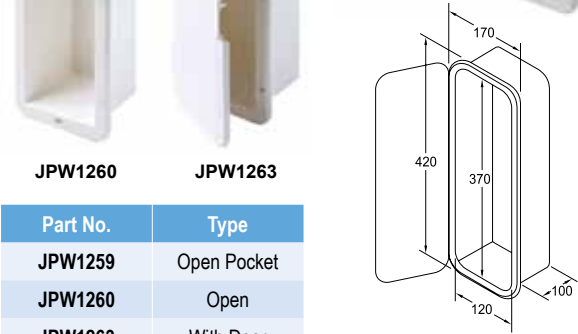

JPW1260

JPW1263

Part No.	Type
JPW1259	Open Pocket
JPW1260	Open
JPW1263	With Door

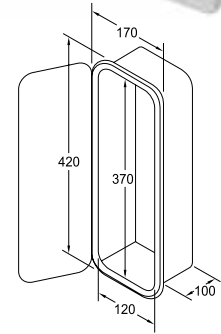

JPW1261

JPW1264

Part No.	Type
JPW1261	Open
JPW1264	With Door

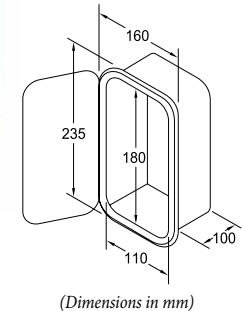

JPW1262

JPW1265

Part No.	Type
JPW1262	Open
JPW1265	With Door

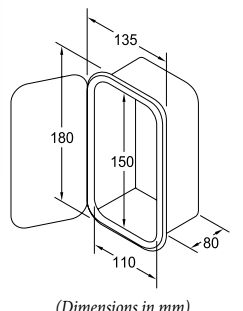

JPW1266

Open Tapered

Part No.	Type
JPW1266	Open Tapered

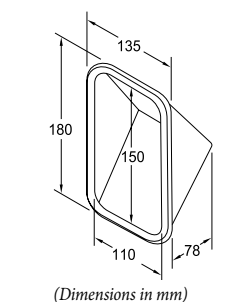



### Glove Box - Standard

Strong, lightweight glove box with stainless steel hinge pins and lock.

- Supplied with pre-installed lock, two keys and four countersunk mounting screws.



JPW5156

Part No.	Door Size (mm)	Depth Behind Dash (mm)	Cut-out Size (mm)
JPW5153	340 x 140	155	300 x 100
JPW5156	Replacement Lock and Two Keys		

### Glove Box with Drink Holders

Lockable glove box with textured finish. Strong quad hinged front cover complete with two folding drink holders.

- Cup holders suit standard cans and bottles and adjust to smaller containers.
- Complete with lock set fitted, two keys and six stainless steel fastening screws.



JPW5156

Part No.	Door Size (mm)	Depth Behind Dash (mm)	Cut-out Size (mm)
JPW5154	340 x 140	155	300 x 100
JPW5156	Replacement Lock and Two Keys		

### Storage Hatch Door - Stainless Steel



Made from 316-grade stainless steel, fully seam welded, hand lished and hand polished to a mirror finish.

- Stainless steel pull handle with integrated lock and keys.
- Flush-mount.



Part No.	Cut-out W x H (mm)	Overall L x W (mm)
JPW12828	380 x 290	420 x 330

### Hatch Holder Springs - Stainless Steel

Holds hatches open and close easily, the ends pivot and rotate for different mounting positions.



Part No.	Length (mm)
JPW19256	210
JPW19257	260

### Flush Hatch Cover Pull Stainless Steel

Hatch cover pull commonly used on deck mounted access hatches, engine covers or floor storage.

- Includes stainless steel washer and rubber gasket.



Part No.	Length (mm)	Stem Dia (mm)	Head Dia (mm)
JPW19233	56	6	31



### Scanstrut Scanpods Deck Mounts



Install your multi-function display device on virtually on any flat surface on board. UV and heat resistant seals made from high tear strength silicone.

- 360° viewing angle swivel and tilt base.
- Added strength with inner bracing plate.
- Overhead mounting optional.
- Supplied uncut.



Part No.	Dimensions L x W x D (mm)
JPW10519	324 x 228 x 167
JPW10520	374 x 243 x 167
JPW10521	392 x 286 x 167
JPW10522	409 x 287 x 167
JPW10523	482 x 396 x 175



### Scanstrut ROKK Mini Mounts



Compact and multi-adjustable mounting system for smartphones, tablets, small fish finders, digital and action cameras and more.

- For devices up to 1.2kg.
- Each part sold separately.

1 JPW10472

2 JPW10485

3 JPW10487

3 JPW10486

Part No.	Description
JPW10472	Phone Clamp Top Plate
JPW10485	360° Adjustable Body
JPW10486	Screw Down Base
JPW10487	Self-Adhesive Base

Complete assembly (phone not included)

### Scanstrut Scanpods Helm Rail Mounts



The saddle system supports the stainless tubing enabling a secure and rigid fit onto pedestal rails from 25mm to 33.7mm diameter.

- UV and heat resistant seals made from high tear strength silicone.
- Secure and watertight installation.
- No drill fixing kit included.
- Supplied uncut.



Part No.	Dimensions L x W x D (mm)
JPW10524	324 x 228 x 167
JPW10525	374 x 243 x 167
JPW10528	467 X 387 X 183



### Scanstrut ROKK Mini Tablet Mount Kits



A tough, compact and multi-adjustable mounting systems for tablets, small fish finders and other digital devices.

- Ratchet adjustable tablet clamp top plate.
- 360-degree adjustable aluminium body.
- Screw down, rail mount or suction cup base.
- Secure metal-on-metal locking system.

#### Screw Down Base

- Fits any flat surface.
- Tough, marine-grade, UV stable materials.

Part No.
JPW10476



#### Rail Mount Base

- Fits a wide range of rails from 19mm – 34mm
- Includes 3 x soft rail grip pad inserts for the perfect fit

Part No.
JPW10477



#### Suction Cup Base

- Fits to any rigid, clean, smooth, non-textured surface.
- Tough, marine-grade, UV stable materials.

Part No.
JPW10480



### Bow Rollers - Polyurethane

To suit bow sprits, these outlast conventional rollers, are less abrasive and reduce any noise when in use.

- Made from hard-wearing red polyurethane.
- Suitable for fibreglass hulls.

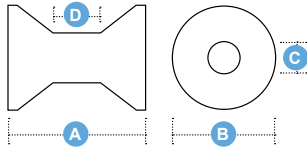

Part No.	Type	Dimensions (mm)			
		A	B	C	D
JPW4111	2" Bow Roller	50	50	13	13
JPW4211	3" Bow Roller	75	70	17	27

### Bow Rollers - Polyethylene

Hard durable, high density polyethylene (HDPE) rollers are lightweight and impact resistant. High quality and notably quiet.

- Suitable for aluminium hulls.

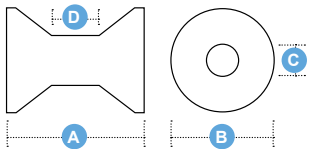

Part No.	Colour	Dimensions (mm)			
		A	B	C	D
JPW4213	Red	74	70	17	27
JPW4214	Blue	74	70	17	27

### Viper Pro Deluxe Anchor Rollers

316-grade stainless steel anchor rollers made from 5mm plate, hand polished to a mirror finish.

- Stainless steel bolts, nuts and washers provided.
- 2x 8mm pre-drilled mounting holes.

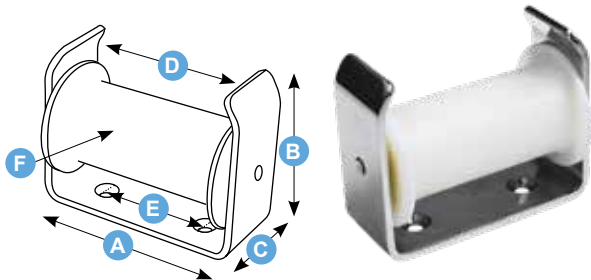

Part No.	Type	Dimensions (mm)					
		A	B	C	D	E	F
JPW12834	Small	130	105	50	100	70	53
JPW12835	Large	205	105	50	175	105	53

### Small Bow Roller - Aluminium

Small bow roller made from cast aluminium.

- Suitable as a weld-on bow roller for aluminium boats.

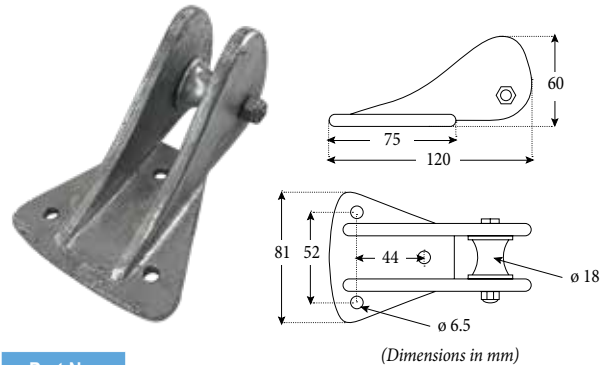

Part No.	JPW4220
----------	---------

### Small Bow Roller - Stainless Steel

Small 304-grade heavy duty stainless steel fixed bow roller.

- Three 9.5mm fixing holes and black roller.

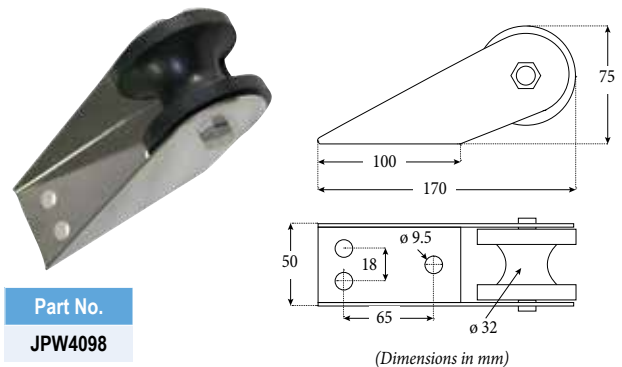

Part No.	JPW4098
----------	---------

### Cast Stainless Steel Bow Rollers

Cast 316-grade stainless steel bow rollers finished to a high polish.

- Saddle strap to retain anchor and rode during recovering anchor.
- Designed for use with Danforth anchors, Delta/Fixed Head anchors, Plough anchors and Claw anchors.

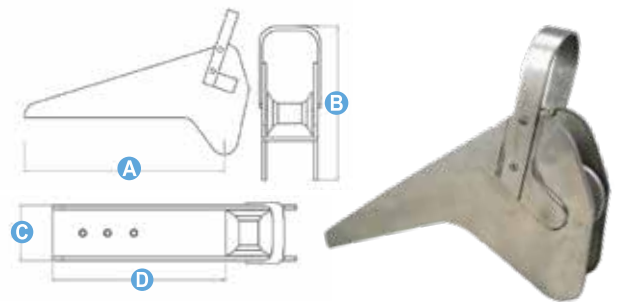

Part No.	Suits Anchor Size (kg)	Dimensions (mm)			
		A	B	C	D
JPW4221	10	380	196	67	261
JPW4222	15	480	240	75	300
JPW4223	20	590	235	78	340
JPW4224	30	590	240	78	340

**Bow Roller - Stainless Steel**

316-grade stainless steel bow roller with spring loaded removable retaining pin and single stainless steel roller assembly

- Highly polished finish.

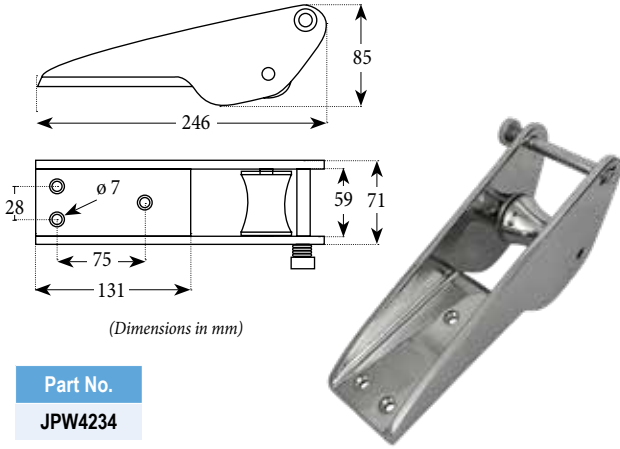

Part No.  
JPW4234

**Bow Roller - Stainless Steel**

316-grade stainless steel bow roller with brushed finish.

- Spring loaded retaining pin
- Single roller assembly.

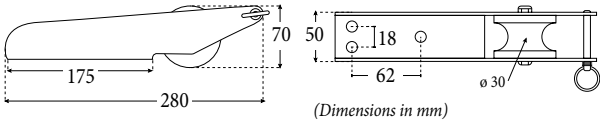

Part No.	Dimensions (mm)						
	A	B	C	D	E	F	G
JPW4099	70	280	175	50	30	62	18

**Self-Launching Bow Rollers - Stainless Steel**

Heavy duty marine-grade stainless steel. Designed for use with Delta/Fixed Head anchors and Rocna Original, Vulcan and Fisherman anchors.

- 2x white anchor guide rollers.
- Suit rope size 6mm or larger.

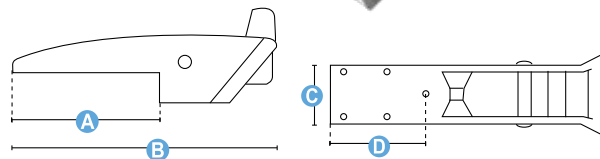

Part No.	Dimensions (mm)				Suits Anchor Size (kg)		
	A	B	C	D	Delta	Rocna	Fisherman
JPW4231	225	415	76	150	6-10	4-6	4-6
JPW4232	390	585	80	265	10	4-10	4

**Viper Pro Deluxe Single Bow Roller**



Made from 5mm 316-grade stainless steel, this roller is self-launching and suitable to fit almost any anchor. Allows for free falling, correct alignment upon retrieval and reduces rope chafe.

- Stainless steel bolts, nuts and washers provided.
- 4x 8mm pre-drilled mounting holes.
- Polished to a mirror finish.
- Single roller assembly.

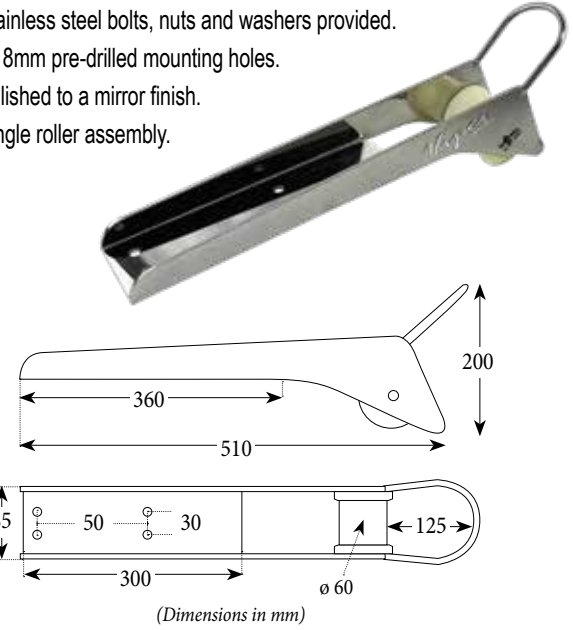

Part No.  
JPW12832

**Viper Pro Deluxe 3 Roller Bow Rollers**



Self-launching and designed to fit most plough anchors. Made from 5mm plate 316-grade stainless steel, polished to a mirror polish.

- Safety loop to stop rope from sliding over.
- 3x high performance nylon rollers.
- 4x 8mm pre-drilled mounting holes.

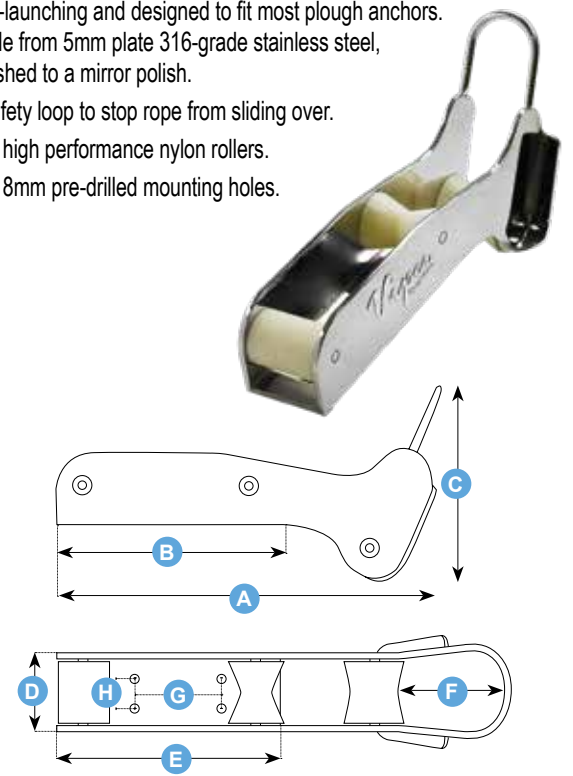

Part No.	Dimensions (mm)							
	A	B	C	D	E	F	G	H
JPW12830	370	240	210	70	210	153	90	30
JPW12831	495	290	255	95	350	182	175	42

### Cross Bollards - Aluminium

Cross bollards made from cast marine-grade aluminium alloy.

- Can be welded and fastened to deck or drilled out and screwed into position.



Part No.	Base Dimensions L x W (mm)	Height (mm)
JPW4247	60 x 60	76 (3")
JPW4248	88 x 75	100 (4")
JPW4249	88 x 88	155 (6")

### Cross Bollard - Aluminium

Australian made cast marine-grade aluminium bollards that can be welded or fastened to a deck.

- 8mm thick base.



Part No.	Base Dimensions L x W (mm)	Height (mm)
JPW4250	97 x 73	100 (4")

### Cross Bollard - Stainless Steel

Heavy duty 316-grade stainless steel cross bollard, designed to fit on most small to large boats.

- Polished finish for a great looking shine.
- Four 4.5mm fastening holes.



Part No.	Base Dimensions L x W (mm)	Height (mm)
JPW4252	60 x 60	80 (3")

### Horn Bollards - Stainless Steel

Quality mirror-polished 316-grade stainless steel bolt-thru style, attached from underneath the cleat.

- Ideal for larger yachts and cruisers.
- Robust construction for the use of large ropes.
- Use as a fairlead or stern chock.



Part No.	Base Dimensions L x W (mm)	Height (mm)	Hole Centres (mm)	Max Rope Dia (mm)
JPW4243	158 x 58	60	70	45
JPW4244	200 x 68	66	80	60
JPW4245	233 x 70	80	90	60

### Split Bollards

Cast 316-grade stainless steel split bollards with or without pin, allows for securing the chain into the bollard.

- Polished finish and gentle rake.



JPW4215



JPW4216 / JPW4218

Part No.	Base Dimensions L x W (mm)	Height (mm)	Chain Size (mm)	Pin
JPW4215	60 x 60	84	8 - 10	No
JPW4216	60 x 60	84	8 - 10	Yes
JPW4218	85 x 85	115	10 - 13	Yes

### Fairleads Straight (Bow Chock) - Stainless Steel

- Cast 316-grade stainless steel with a highly polished finish.
- Two 6mm fastening holes.
- Sold individually.



Part No.	Dimensions L x W (mm)	Hole Centres (mm)	Suits Rope Size (mm)
JPW19019	(5") 127 x 25	103	16
JPW19022	(6") 152 x 25	130	19

### Fairleads Stainless Steel (Bow Chock)

Cast 316-grade stainless steel fairleads.

- Sold as pair - port and starboard.



Part No.	Dimensions L x W x H (mm)	Hole Centres (mm)	Suits Rope Size (mm)
JPW19025	(6") 150 x 34 x 32	125	14
JPW19026	(8") 200 x 38 x 38	165	16
JPW19027	(10") 250 x 48 x 40	210	18

### Fairleads Heavy Duty Solid Base - Stainless Steel

Cast 316-grade stainless steel fairleads, sold as a pair.

- 6mm countersunk fastening holes.



Part No.	Overall Length (mm)	Max Rope Dia (mm)
JPW19023	152	19

**Star Cleat with Studs - Stainless Steel**

Cast 316-grade stainless steel 'STAR' deck cleat.

- Supplied with two 8mm threaded stud mounting rods, nuts and washers.



Part No.	Dimensions L x H (mm)	Hole Centres (mm)
JPW19056	(8") 200 x 50	95

**Small Low-Profile Cleats - Stainless Steel**

Cast 316-grade stainless steel, corrosion-resistant, open-base deck cleat.

- Four 6mm countersunk fastening holes.



Part No.	Top L x H (mm)	Base L x W (mm)	Hole Centres (mm)
JPW19038	(4") 100 x 25	42 x 35	30 x 25
JPW19039	(5") 125 x 28	57 x 47	41 x 30

**Large Low-Profile Cleats - Stainless Steel**

- Cast 316-grade stainless steel, highly polished cleat.
- Four 6mm countersunk fastening holes.



Part No.	Dimensions L x H (mm)	Hole Centres (mm)
JPW19040	(6") 150 x 30	50 x 42
JPW19041	(8") 200 x 38	57 x 41
JPW19042	(10") 250 x 42	57 x 46
JPW19044	(12") 300 x 55	95 x 50

**Slimline Cleats - Stainless Steel**

Cast 316-grade stainless steel standard slimline bar open base deck cleat.

- Four hole mounting positions.



Part No.	Dimensions L x H (mm)	Hole Centres (mm)
JPW19028	(4") 100 x 25	48 x 22
JPW19029	(5") 125 x 26	55 x 25
JPW19030	(6") 150 x 30	55 x 26
JPW19031	(8") 200 x 35	75 x 28
JPW19032	(10") 250 x 45	95 x 44

**Cleats with Oval Tube - Stainless Steel**

Surface mounted oval tube cleats made from 316-grade stainless steel with a highly polished mirror finish.

- Bolt-thru style attached from underneath (bolts not supplied).



Part No.	Top L x H (mm)	Base L x W (mm)	Bolt Size	Hole Centres (mm)
JPW19058	150 x 45	90 x 31	M8	47
JPW19059	200 x 58	120 x 35	M10	69
JPW19060	250 x 80	160 x 50	M16	84

**Heavy Duty Cleats - Stainless Steel**

Cast 316-grade stainless steel and countersunk mounting holes.



Part No.	Dimensions L x H (mm)	Hole Centres (mm)	Mounting Hole Ø (mm)
JPW19043	(8") 200 x 35	73 x 35	7
JPW19033	(10") 250 x 42	95 x 46	8.5
JPW19034	(12") 300 x 48	100 x 51	8.5

**Heavy Duty Weld-On Cleats - Aluminium**

Weld-on base cleat available in three sizes.

- Designed for the OEM boat builder and long-life service.



Part No.	L x W x H (mm)	Base L x W (mm)
JPW5215	(10") 250 x 37 x 58	113 x 74
JPW5216	(12") 300 x 40 x 67	119 x 87
JPW5217	(13.5") 350 x 45 x 80	150 x 103

**Dock Cleats - Cast Aluminium**

Heavy duty alloy dock cleats for marinas, wharves, pontoons, etc.

- Solid weld-on base with large opening for mooring ropes.
- Two 13mm fastening holes.



Part No.	Top L x H (mm)	Base L x W (mm)	Hole Centres (mm)
JPW4241	290 x 90	180 x 45	105
JPW4242	350 x 105	200 x 72	125

### Folding Cleats - Stainless Steel

Heavy-duty cast 316-grade stainless steel low profile folding cleat.

- Indented finger lift for easy retrieval, simply push to fold away to create a flush profile.



Part No.	L x W (mm)	Height Closed (mm)	Height Open (mm)	Mounting Hole Ø (mm)
JPW19050	155 x 54	13.5	47	8
JPW19051	202 x 72	15	62	10

### Lifting Ring 150mm Cleat - Stainless Steel

Polished 316-grade stainless steel 150mm cleat with a 25mm hole for securely lifting or tying off.

- Secure by screw down or via internal threaded rod.



Part No.	Length (mm)	Eye Ø (mm)	Hole Cut-Out (mm)	Base Ø (mm)	Internal Thread (mm)
JPW19045	150	25	25	47	15 (UNC)

### Flush Pull-Up Cleats - Stainless Steel

Polished 316-grade stainless steel cleat.

- Pulls up from base and sits almost flush on deck when not in use.

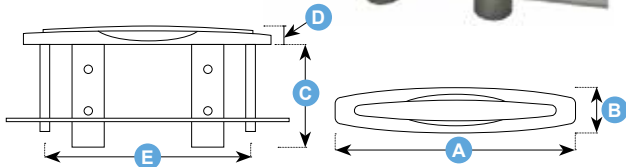

Part No.	Dimensions (mm)				
	A	B	C	D	E
JPW19013	125	31	50	10	97
JPW19014	150	31	62	10	125
JPW19015	200	46	83	14	155

### Cleats Black Nylon

Featuring a flat base and two central fastening holes through the cleat posts.



Part No.	Top L x W (mm)	Base L x W (mm)	Height (mm)	Hole Centres (mm)
JPW5523	100 x 14	54 x 14	20	28
JPW5524	125 x 17	64 x 18	30	36
JPW5525	150 x 22	75 x 22	35	42
JPW5526	200 x 24	84 x 23	40	48

### Flush Pull-Up Cleats - Polished Stainless Steel

Surface mounted cleat made from 316-grade stainless steel with a highly polished mirror finish.

- Pulls up from base and sits almost flush on deck when not in use.
- Strong stainless steel mounting bolts sit below deck.

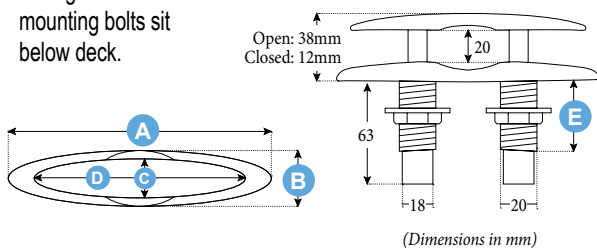

Part No.	Dimensions (mm)				
	A	B	C	D	E
JPW19011	127	32	107	16.5	42
JPW19012	150	36	136	18	44



### Aluminium Scuppers

- High quality aluminium alloy transom drain scuppers or ventilators.
- Spring-loaded with strong stainless spring and watertight sealing gasket.
  - Ideal vents for draining the deck of your boat, air pressurising your caravan, van body, or as a vent to allow air to flow in.
  - Repair service kits also available.



**JPW4261 / JPW4271**  
White Powder Coated

**JPW4260 / JPW4260**  
Plain Aluminium

Part No.	Type	Size	L x W (mm)
JPW4260	Plain Aluminium	Small	167 x 112
JPW4261	White Powder Coated	Small	167 x 112
JPW4270	Plain Aluminium	Large	240 x 147
JPW4271	White Powder Coated	Large	240 x 147

### Aluminium Scupper Repair Kits

- Kits contains 1x foam seal and 1x spring.
- Suits Aluminium Scuppers above.



Large Spring

Small Spring

Foam Seal

Part No.	Type	Suits Scupper Size
JPW4272	Foam Seal and Spring	Small
JPW4273	Foam Seal and Spring	Large
JPW4279	Spare Spring only	Small



### Plastic Nylon Scuppers

- Spring-loaded with strong stainless spring and watertight sealing gasket.
- Ideal vents for draining the deck of your boat, air pressurising your caravan, or as a vent to allow air to flow in.



**JPW6262 / JPW6264**  
Black

**JPW6263 / JPW6265**  
White

Opening Lip

Part No.		Dimensions L x W (mm)
White	Black	
JPW6263	JPW6262	175 x 120
JPW6265	JPW6264	240 x 147
JPW6261	Replacement scupper spring	

### Water Scoop Bracket for Live Bait Tanks

- 316-grade stainless steel, solidly constructed bracket ideal for circulating fresh sea water through your bait tank while under way.
- Suits 12mm hose.
  - Australian made.



**Part No.**  
JPW3805

### Water Scoop Bilge Pump Bracket for Live Bait Tanks

- 316-grade stainless steel bilge pump bracket with water scoop, for circulating fresh sea water through your bait tank while under way or stationary.
- Suits old and new Rule 360 and 500 bilge pumps.
  - 'U' shaped clamp to hold pump in place.



\*Pump not included

**Part No.**  
JPW3806



### Recess Fuel Breathers - Stainless Steel

This recessed breather provides a flush to hull installation. It can also be used for surface mount installation, by removing the flush mount "cup" and reversing the backing plate.

- Made of cast 316-grade stainless steel.
- Suitable for all types of hull material.



Part No.	Suits Hose (mm)	Type
JPW19153	16	90° Angle
JPW19154	16	Straight

### Deck Fill Stainless Steel with Vent FUEL 38mm

Heavy duty cast 316 grade stainless steel deck fill with breather vent and FUEL identification stamped into the highly polished top.

- Suits 16mm breather hose.

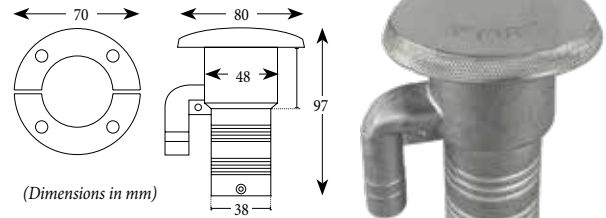

Part No.	Hose Size (mm)
JPW19268	38

### Recess Fuel Breather - Polished Stainless Steel

316-grade stainless steel recessed fuel breather vent with a 90 degree angled barb

- Additional flange for thinner hulls (3.5mm).



Part No.	Suits Hose (mm)	Type
JPW19126	16	90° Angle

### Keyless Deck Fillers - Stainless Steel

Flush mount cast 316-grade stainless deck fillers with a flip-up key to ensure easy removal.

Features coarse thread, 'O' ring seal, retaining chain and filler type identification moulded into the lid.

- 4mm countersunk fastening holes.

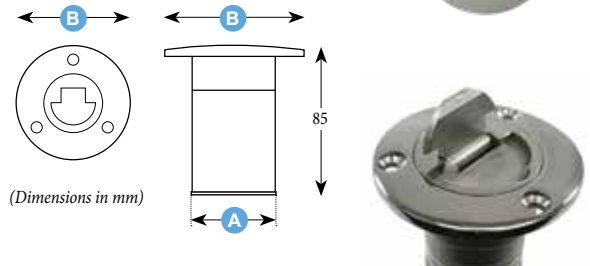

Part No.	Type	Dimensions (mm)	
		Hose Size (A)	Rim Ø (B)
JPW19270	Fuel	38	74
JPW19271	Fuel	50	87
JPW19272	Diesel	38	74
JPW19273	Diesel	50	87
JPW19274	Water	38	74
JPW19275	Water	50	87

### Fuel Breather Vent - Stainless Steel

316-grade stainless steel fuel breather vent, slightly recessed with a straight barb.



Part No.	Suits Hose (mm)	Type
JPW19124	19	Straight

### Fuel Breathers - Stainless Steel

316-grade stainless steel with a round head, suitable for all types of hull material.

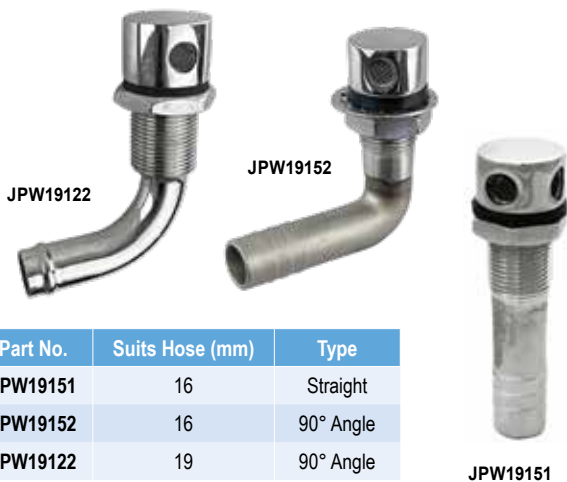

Part No.	Suits Hose (mm)	Type
JPW19151	16	Straight
JPW19152	16	90° Angle
JPW19122	19	90° Angle

### Keyless Deck Fill with 45deg Base Stainless Steel FUEL 38mm

Same style as above with a 45deg angled hose connection.

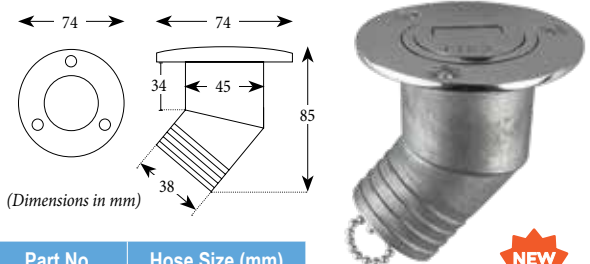

Part No.	Hose Size (mm)
JPW19269	38

### Opening Key Deck Fillers - Stainless Steel

High quality heavy duty cast 316-grade stainless steel deck fillers.

- Supplied complete with stainless steel retaining chain, 'O' ring seal and key.

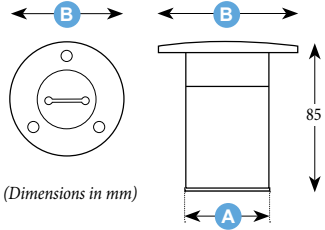

Part No.	Type	Dimensions (mm)	
		Hose Size (A)	Rim Ø (B)
JPW19090F	Fuel	38	75
JPW19093F	Fuel	50	80
JPW19090	Petrol	38	75
JPW19093	Petrol	50	80
JPW19091	Diesel	38	75
JPW19096	Diesel	50	80
JPW19092	Water	38	75
JPW19098	Water	50	80
JPW19094	Waste	38	75
JPW19097	Waste	50	80
JPW19099	Spare Deck Fill Key 38 & 50mm deck fillers.		
JPW19262	Replacement Retaining Chain		

### Deck Fillers - Nylon

Universal type fillers featuring a quick and easy opening cap with 'O' ring seal and stainless steel safety chain.

- Supplied with stick-on name plates (Water, Waste, Petrol, Diesel, Fuel and Gas).
- No tools required for opening; simply turn by hand.



Part No.	Hose Size (mm)
JPW2628	38
JPW2629	50

### Lockable Fuel Deck Fillers - Stainless Steel

Polished stainless steel fuel deck fillers, with stainless steel retaining chain, 'O' ring seal and FUEL stamped on lid.

- Includes lock and 2x stainless steel keys.



Part No.	Suits Hose (A) mm
JPW19260	50
JPW19265	30 and 50

**JPW19260**  
Straight base

**JPW19265**  
Stepped base to suit two hose sizes

### Lockable Fuel Deck Filler with 45deg Base - Stainless Steel

Same style as above with 45° angled base.

- Includes lock and 2x stainless steel keys.

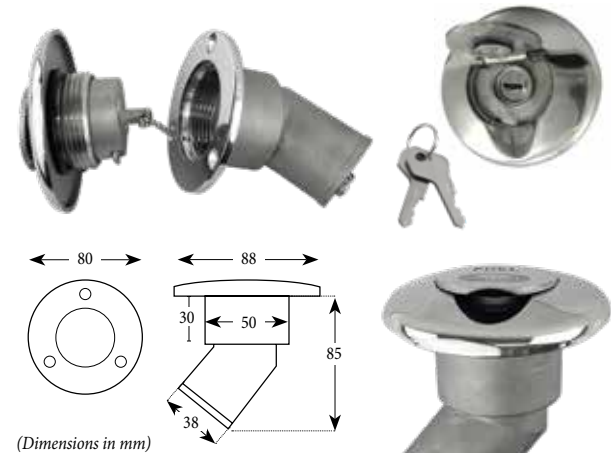

Part No.	Hose Size (mm)
JPW19267	38



### Replacement Retaining Chain for Deck Fillers

Keeps the deck filler cap secured to the base.

- Total length: 195mm

Part No.
JPW19262



### Nairn Inspection Ports

Manufactured to high tolerances to provide high strength, durability and water-tightness.

- All models include 'O' ring seals.
- Rims and coloured lids are made from ABS plastic.
- Clear lids are made from polycarbonate plastic, to give both high transparency and impact resistance.
- 5" and 6" ports are available with removable kit bags made from woven nylon.

Part No.		Type	Cut-Out (mm)	I.D. (mm)	O.D. (mm)	Mounting Holes
White	Black					
JPW6030	JPW6031	4" - Screw-in	110	100	144	6 x 4.5mm
JPW6032	JPW6033	5" - Screw-in	140	125	170	6 x 4.5mm
JPW6041	JPW6042	5" - With Kit Bag	140	125	170	6 x 4.5mm
JPW6034	JPW6035	6" - Screw-in	166	150	194	8 x 4.5mm
JPW6040	JPW6043	6" - With Kit Bag	166	150	194	8 x 4.5mm
JPW6036	-	8" - Pry Out	210	190	250	6 x 6mm



### Nairn Inspection Port Replacement Lids

• Clear lids are made from polycarbonate plastic, to give both high transparency and impact resistance.

Part No.			Type	O.D. (mm)
White	Black	Clear		
JPW6060	JPW6055	JPW6050	4" - Lid Only	113
JPW6061	JPW6056	JPW6051	5" - Lid Only	138
JPW6062	JPW6057	JPW6052	6" - Lid Only	160
JPW6063	-	-	8" - Lid Only	200



Spare clear lid to suit Nairn ports

### Spare O-Rings

Part No.	Size
JPW6070	4" (100mm)
JPW6071	5" (125mm)
JPW6072	6" (150mm)
JPW6073	8" (200mm)



### Inspection Ports - Full Cover Lid

Made from high density polymer with a textured surface and screw-in threaded lid that covers screw holes.

- Finger grip opening lid with rubber ring to seal with base.
- Six 4.5mm mounting holes.



Part No.		Type	Cut-Out (mm)	I.D. (mm)	O.D. (mm)
White	Black				
JPW6045	JPW6044	6" - Screw Out	163	152	210

### Inspection Port - Smooth Lid

Made from durable UV-resistant ASA white plastic, smooth surface style with screw-in finger grips on lid. Pry-out lid has no finger grip holes.

- Includes 'O' ring seal.
- Six 4.5mm mounting holes



JPW6046

JPW6047 / JPW6049

Part No.	Type	Cut-Out (mm)	I.D. (mm)	O.D. (mm)
JPW6047	4" Screw-in	120	100	155
JPW6046	6" Pry-out lid	165	155	205
JPW6048	6" Screw-in	165	150	205
JPW6049	8" Screw-in	210	200	250

### Inspection Ports

Made from ABS plastic, screw-in threaded lid with flush mounted style.

- Finger grips with rubber ring to seal.
- Six 4.5mm mounting holes.



Part No.		Cut-Out (mm)	I.D. (mm)	O.D. (mm)
White	Black			
JPW6074	JPW6075	110	102	145
JPW6076	JPW6077	135	128	170
JPW6078	JPW6079	160	155	205

### Adjustable Opening Key for Deck Plates

Easily open any size deck plate.

Part No.
JPW6059



### Deck Plates Finger Grip Opening - Stainless Steel

Heavy duty 316-grade polished stainless steel with a handy finger grip opening mould instead of the standard key system.



Part No.	Cut-Out (mm)	I.D. (mm)	O.D. (mm)
JPW19195	87	83	123
JPW19196	110	102	147
JPW19197	135	127	173
JPW19198	162	150	196

### Deck Plates - Stainless Steel

Heavy duty 316-grade stainless steel deck plate with mirror polish.

- Rubber 'O' ring seal for a watertight closure.
- Includes opening key.

JPW19101A/B  
Replacement Key



Part No.	Hole Dia		Outside Diameter (mm)	Cut-out Size (mm)
	(in)	(mm)		
JPW19100	4	100	140	110
JPW19102	5	127	176	136
JPW19103	6	152	198	162
JPW19101A	Replacement Key suits 4" Deck Plates			
JPW19101B	Replacement Key suits 5" to 8" Deck Plates			

### Aluminium Weld-On Deck Plates with Acetal Lid

Heavy duty marine-grade aluminium weld-on base and 20mm thick acetal lid with key holes for opening.

- Rubber 'O' ring seal ensures a watertight seal.

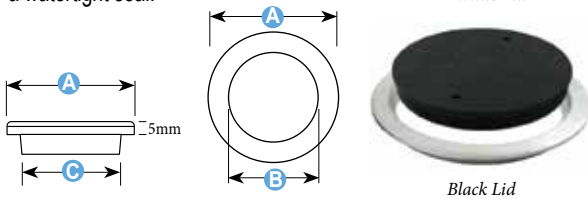

Part No.		Dimensions (mm)		
White Lid	Black Lid	A	B	C
JPW5208	JPW5207	145	(4") 100	118
JPW5210	JPW5209	195	(6") 150	165
JPW5206	JPW5205	245	(8") 200	217

### Opening Keys To Suit Weld-on Deck Plates



Part No.	A (mm)	Suits Lid Size (mm)
JPW5211B	70	100
JPW5211	120	150 and 200

### Bomar Waterproof Aluminium Deck Plate



This commercial-grade, heavy-duty aluminium inspection port is 100% waterproof. A flush ring pull latch enables complete removal of the lid.

- Corrosion-resistant aluminium with a non-skid checker plate surface.
- Thick watertight rubber seal.
- Six 5mm mounting holes.



Part No.	Cut-Out (mm)	I.D. (mm)	O.D. (mm)	Height (mm)
JPW171675	276	223	306	30

### Cast Alloy Tank Filler / Drain Bung with Slotted Cap

Base is cast aluminium that can be welded or screwed to surface.

- Includes rubber 'O' ring seal and white acetal slot cap.

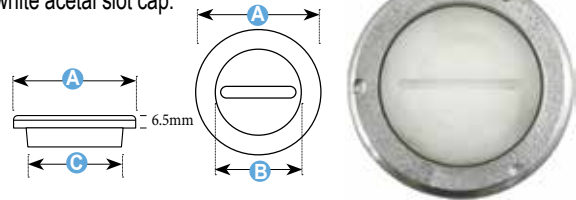

Part No.	Dimensions (mm)		
	A	B	C
JPW5212	93	55	75



### Cast Aluminium Drain Bungs

Cast aluminium drain plug designed to be welded or drilled for screw-in installation. Supplied with rubber 'O' ring seals in the cap.

- Replacement caps are available in aluminium or black acetal.



Part No.	Description	Dimensions (mm)		
		A	B	C
JPW5213	Cast Alloy Bung & Base	72	45	50
JPW5214	Cast Alloy Bung with Acetal Plug	60	45	50
JPW5219	Replacement Aluminium Plug & O-ring 38mm			
JPW5220	Replacement Black Acetal Plug & O-ring 38mm			

### Transom Well Drain 55mm

White nylon fine threaded drain with push-on grip flanged end fitting.

- Can be used for draining motor or anchor wells.
- Simply cut to length required.



Part No.	Overall Length (mm)	Cut-out (mm)
JPW5420	59	25

### Rubber Trim Ring - Oval

Protect wiring and plumbing from chaffing by neatly finishing holes in bulkheads, engine wells, etc.

- Made from soft black PVC plastic to give excellent weather and chemical resistance.



Part No.	Colour	Hole Size L x W (mm)	Cut-Out L x W (mm)	O.D. Total L x W (mm)
JPW5293	Black	115 x 60	120 x 62	135 x 82

### Oval Hawse Pipe Flange - Stainless Steel

Oval shape hawse pipe made from cast 316-grade stainless steel.

- Used mainly as a rope guide through the gunwale of larger boats.
- Highly polished finish.



Part No.	L x W x H (mm)	Cut-Out (mm)	I.D. Hole (mm)
JPW19000	140 x 64 x 25	103 x 46	93 x 37
JPW19001	238 x 135 x 30	190 x 88	175 x 75

### Rubber Slop Stoppers - Round

Splash proof round slop stopper boot to prevent damage to cables and hoses in engine wells.

- Soft PVC plastic for excellent weather resistance and long term durability.
- 45mm intrusion.



Part No.	Colour	Hole Dia (mm)	Cut-Out (mm)	Outside Dia (mm)
JPW5294	White	50	62	90
JPW5300	Black	50	62	90

### Rectangle Hawse Pipe Flange - Stainless Steel

Rectangle flange with oval cutout used mainly as a rope guide through the gunwale of larger boats.

- Cast 316-grade stainless steel with highly polished finish.



Part No.	L x W x H (mm)	I.D. Hole (mm)
JPW19002	132 x 63 x 25	90 x 37

### Rubber Slop Stopper - Oval

Splash proof oval slop stopper boot that prevents damage to cables and hoses in engine wells, etc.

- Soft black PVC plastic.
- 45mm intrusion



Part No.	Colour	Hole Size L x W (mm)	Cut-Out L x W (mm)	Overall L x W (mm)
JPW5301	Black	115 x 60	120 x 62	135 x 80

### Rubber Trim Ring - Round

Protect wiring and plumbing from chaffing by neatly finishing holes in bulkheads, engine wells, etc.

- Excellent weather and chemical resistance.
- Made from soft PVC plastic.
- 6mm maximum panel thickness.



Part No.	Colour	Cut-Out (mm)	Outside Dia (mm)
JPW5292	Black	65	90

### Rubber Bungs - Black

Tapered rubber bungs suitable for use in dinghies and plugging holes between 11mm and 25mm.

Part No.	Hole Size (mm)	Type
JPW6939	11 - 14	Size 3
JPW6940	16 - 19	Size 7
JPW6941	18 - 21	Size 8
JPW6942	20 - 25	Size 10



### Expansion Bung with Snap Release

Black 25mm bung drain made from flexible, durable nylon.

- Push into tube and snap for a watertight fit.
- Easy-to-use snap handle for release and removal.



Part No.	Hole Size
JPW5411	25mm (1")

### Bungs with Snap Handle

Expansion bung expands when handle is pushed down.

- Made from nylon.

Part No.	To Suit Hole Size (mm)
JPW5358	25
JPW5359	35
JPW5360	40



### Plastic Bung with 22mm Base Cut-Out

Small size drain bung and base, made from UV-resistant marine-grade nylon with fine thread.

- 19mm internal flow size with unique high flow retainer ring design and neoprene 'O' ring seal.
- Two 4mm countersunk fastening holes.
- 19mm bung plug diameter.



Part No.		Description
Single	Bulk Bag of 10	
JPW5372	JPW5372B	Bung & Base Assembly

### Plastic Bung with 25mm Base Cut-Out - Fine Thread

All plastic with plastic washer and retainer lug.

- Fine thread with 19mm internal flow size.
- Two 4mm countersunk fastening holes.
- 19mm bung plug diameter.



Part No.		Description
Single	Bulk Bag of 10	
JPW5391	JPW5391B	Bung & Base Assembly
JPW5390	JPW5390B	Bung Plug only

### Plastic Bung with 25mm Base Cut-Out - Coarse Thread

Standard size, coarse thread drain bung. All plastic with plastic washer and retainer lug.

- 17mm internal flow size.
- 19mm bung plug diameter.

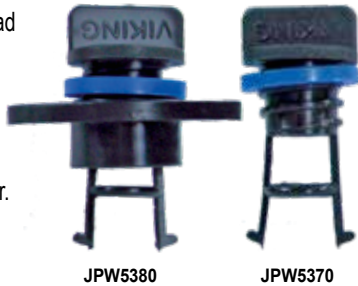

Part No.		Description
Single	Bulk Bag of 10	
JPW5380	JPW5380B	Bung & Base Assembly
JPW5370	JPW5370B	Bung Plug only

### Plastic Bungs with 25mm Base Cut-Out

High quality bung and base made from UV-resistant marine-grade nylon.

- 20mm internal flow size with unique high flow retainer ring design and neoprene 'O' ring seal.
- Two 4mm countersunk fastening holes.
- 20mm bung plug diameter.



Part No.		Description
Single	Bulk Bag of 10	
JPW5392	JPW5392B	Bung & Base Assembly White
JPW5393	JPW5393B	Bung Plug only White
JPW5394	JPW5394B	Bung & Base Assembly Black
JPW5395	JPW5395B	Bung Plug only Black

### Plastic Bungs with 30mm Base Cut-Out

UV-resistant marine-grade nylon bung.

- 25mm internal flow size with unique high flow retainer ring design and neoprene 'O' ring seal.
- Two 4mm countersunk fastening holes.
- 25mm bung plug diameter.



Part No.		Description
Single	Bulk Bag of 10	
JPW5396	JPW5396B	Bung & Base Assembly White
JPW5397	JPW5397B	Bung Plug only White
JPW5398	JPW5398B	Bung & Base Assembly Black
JPW5399	JPW5399B	Bung Plug only Black

### Plastic Bung with 38mm Base Cut-Out

UV-resistant black nylon bung and black washer.

- 30mm internal flow size.
- Two 4mm countersunk fastening holes.
- 30mm bung plug diameter.



Part No.		Description
Single	Bulk Bag of 10	
JPW5400	JPW5400B	Bung & Base Assembly
JPW5410	JPW5410B	Bung Plug only

### Plastic Bungs with 40mm Base Cut-Out

High quality large size drain bung and base manufactured from UV-resistant marine-grade nylon.

- Large 35mm internal flow size with unique high flow retainer ring design and neoprene 'O' ring seal.
- Opening large enough to allow prawn heads, etc. to pass through.
- Four 4mm countersunk fastening holes.
- 35mm bung plug diameter.



Part No.		Description
Single	Bulk Bag of 5	
JPW5365	JPW5365B	Bung & Base Assembly White
JPW5366	JPW5366B	Bung Plug only White
JPW5367	JPW5367B	Bung & Base Assembly Black
JPW5368	JPW5368B	Bung Plug only Black

### Plastic Bungs with 50mm Base Cut-Out

High quality large size drain bung and base manufactured from UV-resistant marine-grade nylon.

- Large 45mm internal flow size with unique high flow retainer ring design and neoprene 'O' ring seal.
- Opening large enough to allow prawn heads, etc. to pass through.
- Four 4mm countersunk fastening holes.
- 45mm bung plug diameter.



Part No.		Description
Single	Bulk Bag of 5	
JPW5361	JPW5361B	Bung & Base Assembly White
JPW5362	JPW5362B	Bung Plug only White
JPW5363	JPW5363B	Bung & Base Assembly Black
JPW5364	JPW5364B	Bung Plug only Black

### Nylon Bung with Stainless Steel Base

Coarse threaded nylon bung plug with polished 316 grade stainless steel base, complete with nitrile seal and retainer lug.

- 25mm internal flow size.
- 19mm plug diameter.
- Two 4mm countersunk fastening holes.

Part No.	Base L x W (mm)
JPW5354	51 x 37



### Drain Bung and Base - Stainless Steel

316 grade stainless steel nut type plug complete with nitrile rubber seal and retainer lug.

- 25mm internal flow size.
- 19mm plug diameter.
- Two 5mm countersunk fastening holes.

Part No.	Base L x W (mm)
JPW5356	50 x 37



### Weld-On Aluminium Drain Bung with Plastic Bung

Large drain plug with cast aluminium housing designed for weld in use, complete with nitrile rubber seal and retainer lug.

- 35mm internal flow size.
- 45mm cut-out.

Part No.	Base L x W (mm)
JPW5374	65 x 75



### Drain Plug Polished Stainless Steel

Polished 316 grade stainless steel 3 piece drain plug, complete with nitrile rubber seal and secure thread for a watertight seal.

- 30mm internal flow size.
- 30mm cut-out.

Part No.	Overall Dia (mm)	Plug Dia (mm)
JPW5353	50	20



### Brass Garboard Drain Plug and Housing

50mm diameter brass housing complete with 3/4" brass drain plug.



Part No.	Description
JPW5225	Brass Garboard Drain Plug And Housing 50mm
JPW5226	Replacement Brass Garboard Drain Plug

### Shock Cord Buttons

Plastic cord button to suit 5-7mm bungee straps.

- High quality and UV-stabilised.

Part No.	Colour
JPW5443	White
JPW5444	Black



### Shock Cord Utility Loops

Shockcord loops for tensioning canopies and covers as well as securing ice box lids, etc. UV-stabilised moulded nylon head fitting with shock cord loop.

Part No.		Loop Size (mm)	Cord Dia (mm)
Black	White		
JPW5500	JPW5505	70	5
JPW5501	JPW5506	80	5
JPW5502	JPW5507	90	5
JPW5503	-	100	5
JPW5504	-	110	5
JPW5509	-	160	5



Length of loop taken from fixing point to extent of loop.

### Lashing Hooks - Nylon

Strong, high quality and UV-stabilised.



Part No.		Type	Suits Cord Dia (mm)	Base Size (mm)
White	Black			
JPW5456	JPW5457	Horizontal	8	42 x 22
JPW5458	JPW5459	Vertical	5	42 x 19

### Lashing Buttons - Nylon

Strong, high quality and UV-stabilised.

Part No.	Colour	Dimensions L x W (mm)
JPW5460	White	33 x 25
JPW5461	Black	33 x 25



### Flat Webbing Saddles - Black Nylon

Strong, high quality and UV-stabilised.



Part No.	Fastening Holes	Webbing Size (mm)
JPW5485	2 x 4mm	25
JPW5487	2 x 5mm	25
JPW5489	2 x 5mm	50

### Nylon Saddle

Strong and high quality.

- Two 5mm fastening holes.

Part No.	Description	Dimensions L x W (mm)
JPW5483	Black Nylon	50 x 17



### Nylon Conduit Saddle

Strong and high quality.

- Two 5mm fastening holes.

Part No.	Hole Diameter
JPW5491	30



### Webbing Strap Buckle - Nylon

Part No.	Description
JPW5463	25mm Nylon Webbing Strap Buckle



### 25mm Webbing Hook - Stainless Steel

- 316 stainless steel canopy strap hook.
- Suits 25mm webbing.

Part No.	Dimensions W x H (mm)
JPW5462	35 x 33



### 25mm Webbing Snap Hook - Stainless Steel

- 316-grade stainless steel, suits 25mm webbing.
- Sold as a pair.

Part No.	Dimensions W x H (mm)
JPW4920	35 x 54



### Shock Cords Olive - Red

Strong, high quality and UV-stabilised.



Part No.	Cord Size (mm)	Dimensions	
		A	B
JPW5464	4 - 5	46	5
JPW5465	5 - 7	67	6.5



### Shock Cords Quick Connect - Black

- Strong, high quality and UV-stabilised.



Part No.	Dimensions (mm)		
	A	B	C
JPW5480	45	3 - 5	7
JPW5481	58	4 - 6	9
JPW5482	70	5 - 8	11





### Stayput Fasteners - Stainless Steel

Made from 316-grade stainless steel, offering increased strength and a smooth appearance. Use to fix fabric to a boat, building or vehicle.

- Secure using a 6g countersunk screw or a 3mm pop rivet.
- Sold individually.



Part No.	Type
JPW5421	Horizontal
JPW5422	Vertical

### Canopy Deck Mounts - Nylon

Nylon plastic with nut and bolt to suit tube end.



Part No.	Size	Dimensions L x W x H (mm)	Gap Size (mm)	Colour
JPW5432	Small	60 x 19 x 20	7	White
JPW5438	Medium	60 x 18 x 30	7	Black

### Stayput Plastic Fasteners - Single

Horizontal or vertical fasteners fix fabric to a boat, building or vehicle. Accepts one single eyelet (9.5mm approx).

- Secure using a 6g countersunk screw or a 3mm pop rivet.
- Supplied as a blister pack of two.



Part No.	Type	Colour
916520	Horizontal	White
916521	Horizontal	Black
916524	Vertical	White
916525	Vertical	Black

### Canopy Thumb Screws - Nylon

High quality, UV-stabilised moulded nylon plastic tops. Used with canopy mounts, making it easier to tighten or loosen your canopy.

- Stainless bolts with 1/4" UNC thread.



Part No.	Type	Bolt Length (mm)	Colour
JPW5427	Star Bolt	15	White
JPW5428	Star Bolt	15	Black
JPW5429	2 Eared	25	White
JPW5433	3 Eared	25	White
JPW5445	3 Eared	25	Black

### Stayput Plastic Fasteners - Double

Horizontal or vertical fasteners fix fabric to a boat, building or vehicle. Accepts two (double) eyelets (9.5mm approx).

- Secure using a 6g countersunk screw or a 3mm pop rivet.
- Supplied as a blister pack of two.



Part No.	Type	Colour
916522	Horizontal	White
916526	Vertical	White

### Canopy Tube Knuckles - Nylon

- UV-stabilised nylon.



Part No.		Suits Tube O.D (mm)
White	Black	
JPW5430	JPW5437	20
JPW5455	JPW5435	25

### Tube Holders - Black Nylon

High quality and UV-stabilised. Ideal for paddles, boat hooks, landing nets etc.

- Size shown is the outside diameter of the tube that it will hold.
- Sold as singles or in pairs.
- 2 pre-drilled fastening holes.



Part No.		Suits Tube Dia (mm)
Single	Pair	
JPW5474	JPW5474P	16
JPW5475	JPW5475P	20
JPW5476	JPW5476P	25
JPW5477	JPW5477P	30
JPW5478	JPW5478P	38
JPW5479	JPW5479P	48

### Canopy Tube Ends - Nylon

- UV-stabilised nylon.



Part No.		Suits Tube I.D (mm)	Suits Tube O.D (mm)	Tongue Size (mm)
White	Black			
JPW5431	JPW5436	16	20	6.5
JPW5452	JPW5453	19	25	8
JPW5454	JPW5434	21	25	7

### Economy Range Canopy Fittings - Black Nylon

Nylon canopy fittings to suit each other.



Part No.	Type
JPW5440	16mm Tube Insert
JPW5441	16 - 18mm Tube Knuckle
JPW5442	Deck Mount with Screw
JPW5446	Thumb Screw Replacement



### Canopy Tube Knuckles - Stainless Steel

Mirror polished cast 316-grade stainless steel, ideal for setting up tube-work around your boat.

- Secure tube with allen key grub screw.

Part No.	Suits Tube O.D.	Type
JPW19074	(7/8") 22mm	Heavy Duty
JPW19077	(1") 25mm	Heavy Duty
JPW19076	(3/4") 19mm	Standard
JPW19106	(7/8") 22mm	Standard
JPW19107	(1") 25mm	Standard



### Hinged Canopy Tube Knuckle Clamps - Stainless Steel

Made from 316-grade stainless steel, the design allows quick and easy fitting to a canopy system without having to disassemble the entire canopy.

Part No.	Suits Tube O.D.
JPW19162	(7/8") 22mm
JPW19163	(1") 25mm



### Canopy Tube Ends - Stainless Steel

Cast 316-grade stainless steel, mirror polished.

Part No.	Suits Tube O.D. (mm)	Suits Tube I.D. (mm)	Tongue Size (mm)
JPW19075	20	16	7
JPW19160	22	19	5.5
JPW19161	25	22	5.5
JPW19159	31	28	9



### Canopy Deck Hinges - Stainless Steel

Cast 316-grade stainless steel mirror polished deck mount hinges.

- Connect canopy to deck or rail.



Part No.	Base Size (mm)	Height (mm)	Gap (mm)	Pin Type	Mount Type
JPW19086	60 x 19	37	9.3	Screw	Deck 90°
JPW19088	52 x 26	29	9.8	Screw	Deck 90°
JPW19108	60 x 16	34	7.7	Release	Deck 90°
JPW19109	61 x 22	37	7.7	Screw	Rail
JPW19110	61 x 22	37	7.7	Release	Rail
JPW19111	56 x 20	34	7.7	Screw	Deck 10°
JPW19121	56 x 20	34	7.7	Release	Deck 10°
JPW19120	Replacement Canopy Mount Quick Release Pin				

### Canopy Tube Ends - Stainless Steel

Mirror polished cast 316-grade stainless steel.

- Small grub screw for securing to tube.

Part No.	Suits Tube O.D. (mm)	Tongue Size (mm)	Type
JPW19119	20	7	Standard
JPW19104	22	7	Standard
JPW19105	25	7	Standard
JPW19072	22	10	Heavy Duty
JPW19073	25	8	Heavy Duty



Standard



Heavy Duty

### Canopy Side Mounts - Stainless Steel

Cast 316-grade stainless steel side deck mount connect canopy to vertical or near vertical surfaces.



Part No.	Base Size (mm)	Height (mm)	Type
JPW19087	50 x 22	28	Standard
JPW19089	72 x 47	32	Heavy Duty

### Round Base Rail Fittings - Stainless Steel

Cast 316-grade stainless steel rail fittings with round base, mirror polished finished.



30° Angle



45° Angle



60° Angle



90° Angle

Part No.	Suits Tube O.D.	Angle Degree
JPW19130	7/8" (22mm)	30°
JPW19131	1" (25mm)	30°
JPW19132	7/8" (22mm)	45°
JPW19133	1" (25mm)	45°
JPW19128	7/8" (22mm)	60°
JPW19129	1" (25mm)	60°
JPW19140	3/4" (19mm)	90°
JPW19134	7/8" (22mm)	90°
JPW19135	1" (25mm)	90°

### 60 Degree Rail Centre and End Fittings

Make your own hand rails to any desired length using these end and centre fittings

- Made from cast 316-grade stainless steel.
- 60° angle.
- Two 4mm fastening holes.



End cap

Centre

Part No.		Suits Tube O.D.
End	Centre	
JPW19054	JPW19053	7/8" (22mm)
JPW19125	JPW19123	1" (25mm)

### Tee Fittings - Stainless Steel

Cast 316-grade stainless steel tee fittings, mirror polished finished.



90° Angle



60° Angle

Part No.	Suits Tube O.D.	Angle Degree	Grub Screws
JPW19141	3/4" (19mm)	90°	One side
JPW19138	7/8" (22mm)	90°	One side
JPW19139	1" (25mm)	90°	One side
JPW19136	7/8" (22mm)	60°	Centre
JPW19137	1" (25mm)	60°	Centre

### Corner Fittings 3 x Tube - Stainless Steel

Cast 316-grade stainless steel fittings, mirror polished finished.

- 3 tubes at 90° angle.



Part No.	Suit Tubes O.D.
JPW19149	7/8" (22mm)
JPW19150	1" (25mm)

### Cross Fittings 4 x Tube - Stainless Steel

Cast 316-grade stainless steel four tube cross fittings, mirror polished finished.



Part No.	Suits Tube O.D.
JPW19142	7/8" (22mm)
JPW19143	1" (25mm)

### End Mount Rail Fittings - Stainless Steel

Cast 316-grade stainless steel hand rail ends with 90° centres and curved finish.

- To suit 22mm and 25mm outside diameter tubes.



Part No.	Suits Tube O.D.	Height (mm)
JPW19145	7/8" (22mm)	38
JPW19146	1" (25mm)	38

### 90 Degree Elbow Rail End Fittings - Stainless Steel

Cast 316-grade stainless steel hand rail ends with 90 degree elbow.



Part No.	Suits Tube O.D.
JPW19147	7/8" (22mm)
JPW19148	1" (25mm)

**Flush Mount Flag Pole Holder - Stainless Steel**

Cast 316 grade stainless steel flag pole holder with 30 degree angled oval head and white plastic removable cap.

- Suits 25mm pole.
- Sits inside the deck/gunwale for a flush finish.
- Three 5mm fastening holes.



Part No.	Head Size L x W (mm)	Cut-out Size (mm)
JPW19069	72 x 50	33

**Surface Mount Flag Pole Holder - Stainless Steel**

Cast 316-grade stainless steel angled style with allen key grub screw to hold flag pole in place.

- Three 4mm fastening holes.



Part No.	Dia of Pole (mm)	Base Dia. (mm)	Height (mm)
JPW19067	25	68	48

**Deck Mount Antenna Base - Stainless Steel**

Straight antenna base with three 6mm fastening holes.

- Suits various internally threaded GPS antennas and other aerials.



Part No.	Base Dia (mm)	Height (mm)	Thread
JPW1286	71	105	3/4"

**Deck Mount Antenna Base - White Nylon**

ABS plastic standard straight antenna base with three 6mm fastening holes.

- Suits various internally threaded GPS antennas and other aerials.



Part No.	Base Dia (mm)	Height (mm)	Thread
JPW1285	70	40	3/4"

**Swivel Mount Antenna Base - White Nylon**

ABS plastic quick release antenna base adjusts in all directions and suits various internally threaded GPS antennas and other aerials.

- Four 8mm fastening holes.
- Stainless steel bolts and nuts.



Part No.	Base Dimensions L x W (mm)	Thread
JPW1284	93 x 65	3/4"

**Rail Mount Antenna Holder - Stainless Steel**

Heavy duty cast stainless steel rail mount antenna base to suit 7/8" or 1" rails.

- Full ratchet angle adjustment and locking handle.
- Suits various internally threaded GPS antennas and other aerials.



Part No.	Suits Tube Size	Thread
JPW19066B	7/8"-1"	3/4"

**Swivel Mount Antenna Base - Stainless Steel**

Heavy duty cast 316-grade stainless steel deck mount antenna base. Suits various internally threaded GPS antennas and other aerials.

- Base mount horizontally or vertically with double angle adjustment and locking handle.
- Four 6mm fastening holes.



Part No.	Dimensions L x W x H (mm)	Thread
JPW19066A	92 x 64 x 108	3/4"

### Boat Rego Numbers and Letters

- Self adhesive white square sticker with black text.
- Meets Department of Transport approval.
- Must be purchased in multiples of 10.
- Small: 65 x 50mm
- Large: 160 x 85mm



Small Part No.	Large Part No.	Number / Letter
JPW5351-0	JPW5350-0	0
JPW5351-1	JPW5350-1	1
JPW5351-2	JPW5350-2	2
JPW5351-3	JPW5350-3	3
JPW5351-4	JPW5350-4	4
JPW5351-5	JPW5350-5	5
JPW5351-6	JPW5350-6	6
JPW5351-7	JPW5350-7	7
JPW5351-8	JPW5350-8	8
JPW5351-9	JPW5350-9	9
JPW5351-A	JPW5350-A	A
JPW5351-B	JPW5350-B	B
JPW5351-C	JPW5350-C	C
JPW5351-D	JPW5350-D	D
JPW5351-E	JPW5350-E	E
JPW5351-F	JPW5350-F	F
JPW5351-G	JPW5350-G	G
JPW5351-H	JPW5350-H	H
JPW5351-I	JPW5350-I	I
JPW5351-J	JPW5350-J	J
JPW5351-K	JPW5350-K	K
JPW5351-L	JPW5350-L	L
JPW5351-M	JPW5350-M	M
JPW5351-N	JPW5350-N	N
JPW5351-O	JPW5350-O	O
JPW5351-P	JPW5350-P	P
JPW5351-Q	JPW5350-Q	Q
JPW5351-R	JPW5350-R	R
JPW5351-S	JPW5350-S	S
JPW5351-T	JPW5350-T	T
JPW5351-U	JPW5350-U	U
JPW5351-V	JPW5350-V	V
JPW5351-W	JPW5350-W	W
JPW5351-X	JPW5350-X	X
JPW5351-Y	JPW5350-Y	Y
JPW5351-Z	JPW5350-Z	Z



### Above Platform Telescopic Ladders - Stainless Steel

316-grade stainless steel above platform telescopic boarding ladders. Compact design includes hinged brackets to allow ladder to retract, flip back and fold over platform when not required.

- 4 different styles available with either 2-steps, 3-steps or 4-steps.
- Secure closed with the bungee cord supplied.

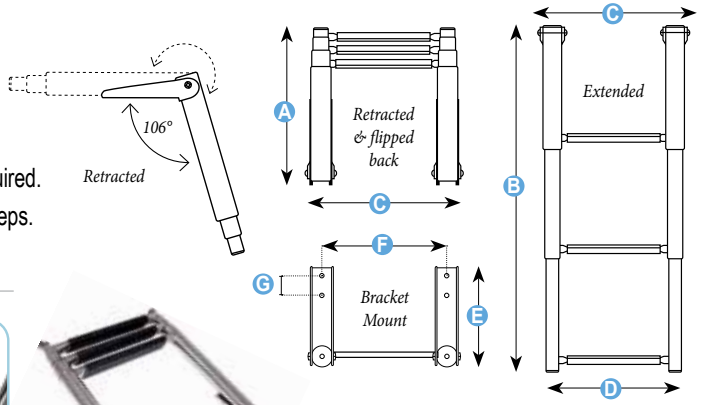

### Telescopic Ladder - Moulded Ribbed Steps

Moulded ribbed nylon tread on each step for comfortable boarding.

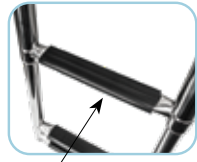

JPW6149 Replacement Nylon Tread



JPW6142 Retracted & flipped back

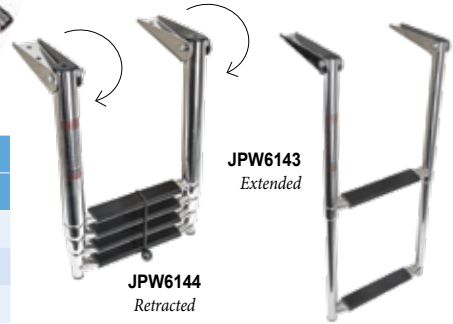

JPW6143 Extended

Part No.	Type	Dimensions (mm) See diagram above						
		A	B	C	D	E	F	G
JPW6143	2-Step	350	600	285	270	150	252	38
JPW6142	3-Step	380	880	295	270	150	255	38
JPW6144	4-Step	405	1160	305	270	165	255	38

### Telescopic Ladders - Double Tube Steps

Steps made from double stainless steel tubes with moulded black nylon for a more stable tread.



JPW6152 Retracted & flipped back

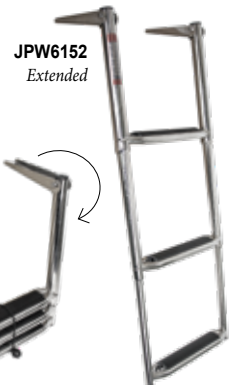

JPW6152 Extended

Part No.	Type	Dimensions (mm) See diagram above						
		A	B	C	D	E	F	G
JPW6152	3-Step	370	875	345	320	180	300	38
JPW6153	4-Step	395	1145	350	220	205	300	63

### Telescopic Ladders - Extra Wide Steps

Extra wide moulded solid nylon steps for sure footing.



JPW6155 Retracted & flipped back



JPW6154 Extended

Part No.	Type	Dimensions (mm) See diagram above						
		A	B	C	D	E	F	G
JPW6154	3-Step	370	875	300	275	180	255	38
JPW6155	4-Step	395	1145	300	275	205	255	63

### Telescopic Ladders - Top Rail

Moulded ribbed nylon tread and top rail with finger grips to make it easier to get into and out of the water.



JPW6149 Replacement Nylon Tread

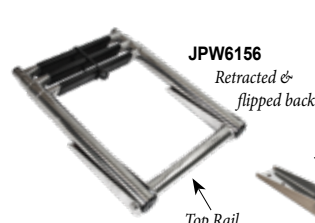

JPW6156 Retracted & flipped back

Top Rail

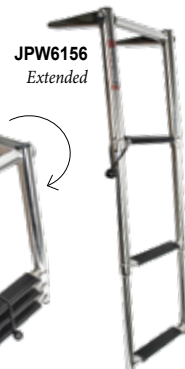

JPW6156 Extended

Part No.	Type	Dimensions (mm) See diagram above						
		A	B	C	D	E	F	G
JPW6156	3-Step	370	875	295	275	180	255	38

JPW6156 Retracted

### Above Platform Telescopic Dive Ladders - Stainless Steel

Heavy duty 316-grade stainless steel above platform telescopic boarding ladder is ideal for diving, with wide open steps giving easy access for divers wearing fins.

- Retracts and flips back over platform when not in use.
- Dual centre post for added strength and assist when climbing.

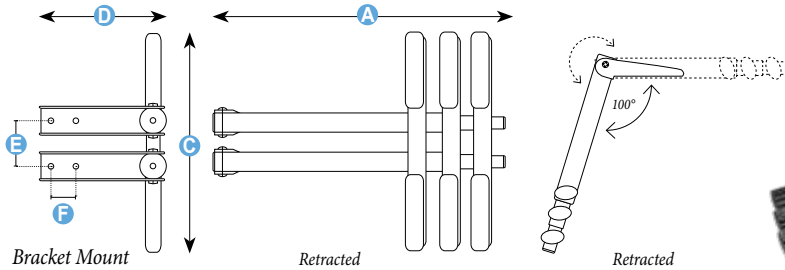

Part No.	Type	Dimensions (mm)					
		A	B	C	D	E	F
JPW6150	3-Step	430	860	335	180	59	33
JPW6151	4-Step	480	1125	335	210	71	33

### Above Platform Telescopic Ladder with Hand Rails - Stainless Steel

316-grade stainless steel telescopic boarding ladder with large top hand rails to make it easier to get into and out of the water.

Hinged brackets allow the steps to be retracted and flipped back, for easy storage when not in use.

- Supplied flat - some assembly is required.
- Secure closed with the bungee cord supplied.

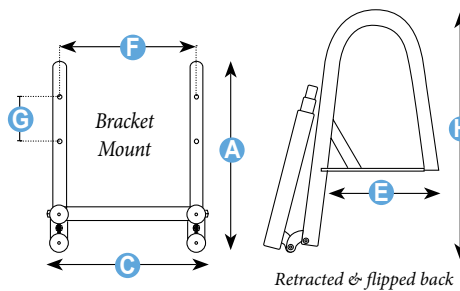

Part No.	Type	Dimensions (mm)							
		A	B	C	D	E	F	G	H
JPW6163	4-Step	390	1431	390	368	270	330	90	554

### Above Platform Telescopic Ladder with Grab Handles - Stainless Steel

Constructed from 316-grade stainless steel this 4-step ladder has two folding grab handles, a top hand rail and heavy duty steps with double tubes for strength and a nylon insert for grip.

- Grab handles and telescopic rungs stow away compactly when not in use.
- Secure closed with the bungee cord supplied.

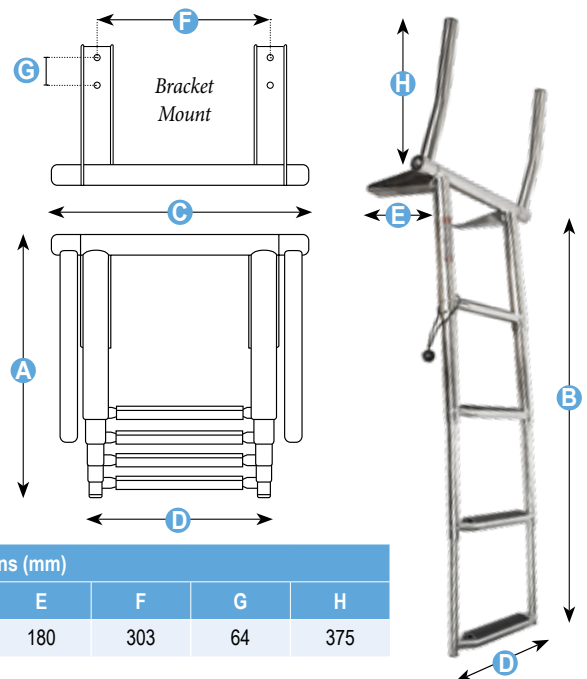

Part No.	Type	Dimensions (mm)							
		A	B	C	D	E	F	G	H
JPW6164	4-Step	470	1140	460	320	180	303	64	375

### Under Platform Telescopic Ladders with Locking Bracket - Stainless Steel

316-grade stainless steel telescopic boarding ladders for under platform mounting. Steps retract into the mounting bracket and have a movable locking bracket to secure into place when not in use.

- Anti-slip and UV-stabilised moulded ribbed steps.

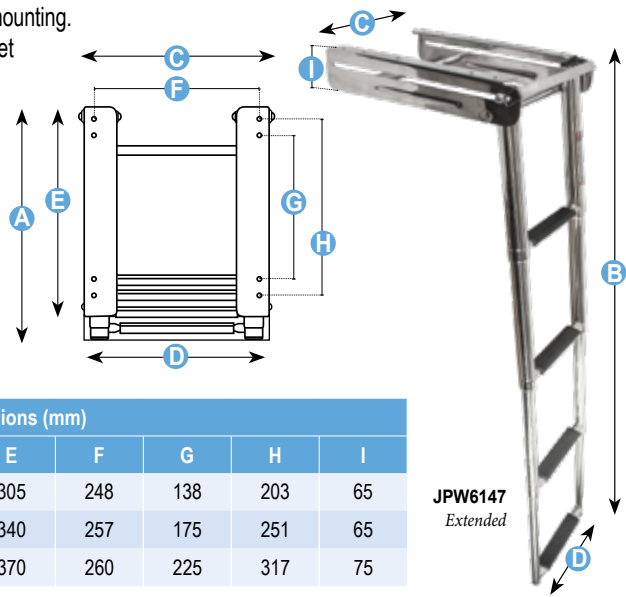
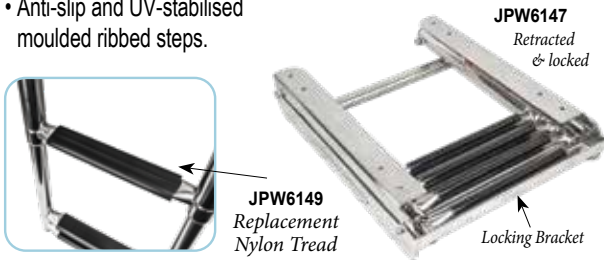

Part No.	Type	Dimensions (mm)								
		A	B	C	D	E	F	G	H	I
JPW6145	2-Step	360	600	290	270	305	248	138	203	65
JPW6146	3-Step	380	880	300	270	340	257	175	251	65
JPW6147	4-Step	400	1160	300	270	370	260	225	317	75

### Under Platform Self Locking Telescopic Ladder - Stainless Steel

316-grade stainless steel telescopic boarding ladders for under platform mounting. Steps retract into the mounting bracket and self-lock securely into place for stowing.

- Anti-slip and UV-stabilised wide ribbed rounded tube steps.

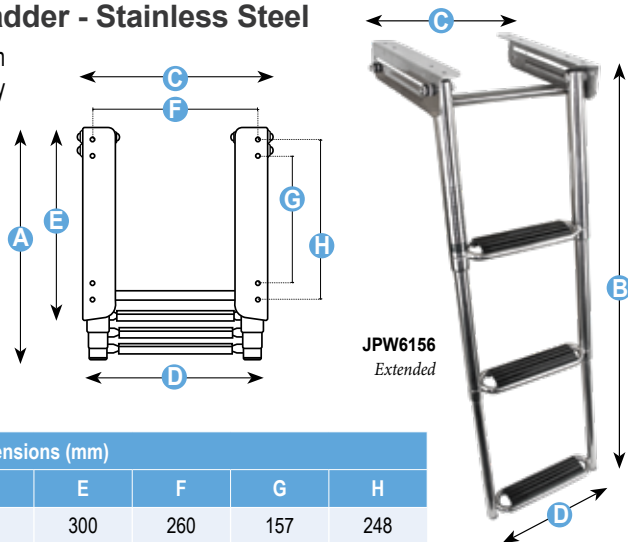
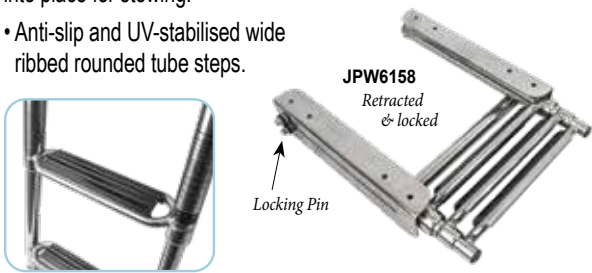

Part No.	Type	Dimensions (mm)							
		A	B	C	D	E	F	G	H
JPW6158	3-Step	380	875	300	275	300	260	157	248

### Inflatable Boat Telescopic Ladders - Stainless Steel

316-grade stainless steel telescopic ladder designed to fit over inflatable boat tubes and secure with two tie down straps supplied. Top rail grab handle makes it easier to get into and out of the water. Complete with a velcro fastening strap, the ladder retracts and folds away compactly when not in use.

- Anti-slip and UV-stabilised moulded ribbed steps.

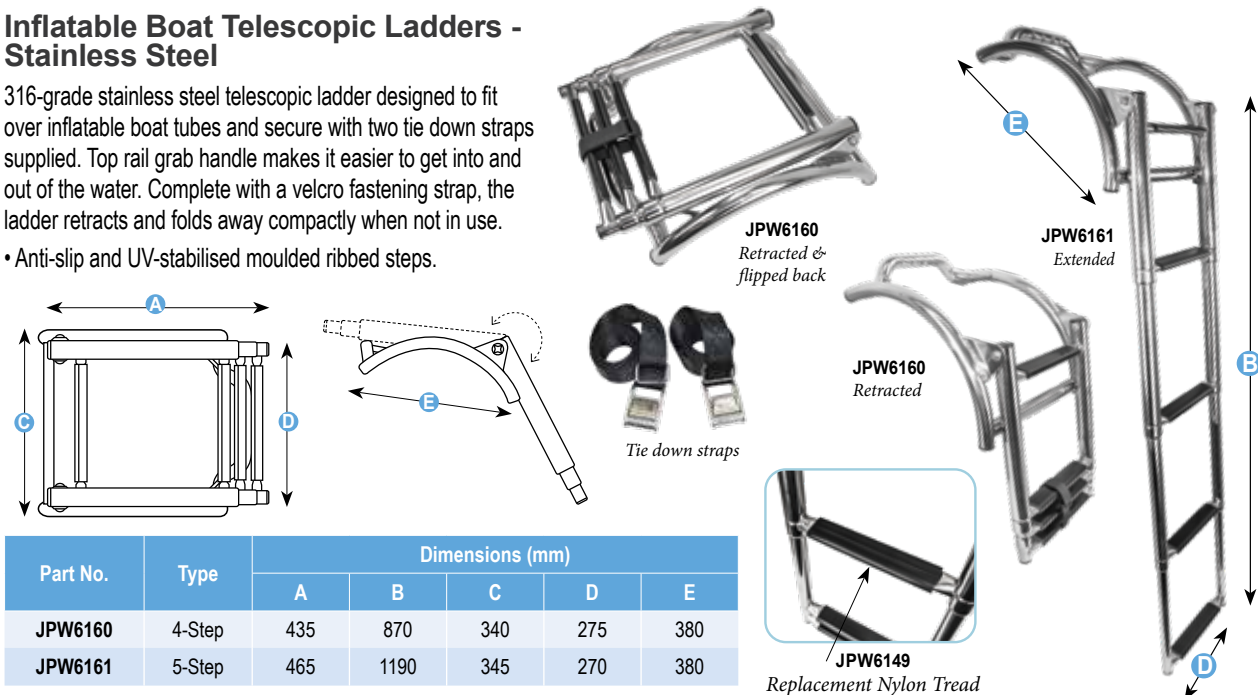

Part No.	Type	Dimensions (mm)				
		A	B	C	D	E
JPW6160	4-Step	435	870	340	275	380
JPW6161	5-Step	465	1190	345	270	380



### Folding Step - Stainless Steel

A heavy duty, solid cast 316-grade stainless steel folding step.

- Two 8mm fastening holes.



Part No.	Body L x W (mm)	Step L x W (mm)
JPW19170	108 x 44	83 x 50

### Transducer Covers - Stainless Steel

Eliminate the spray and splash-back from your boat's transducer, and reduce any water noise that might affect the picture on your sounder.



JPW12847



JPW12848

Part No.	Type	Size (mm)
JPW12847	Small	150 x 135
JPW12848	Large	160 x 200

### Transducer Brackets - Aluminium

Anodised aluminium sliding transducer brackets with adjustable position.

- Removable for easy stowage or security reasons.
- Bracket length : 205mm
- **JPW4933**: Includes 25mm hole.

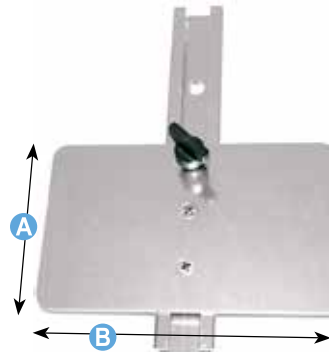

JPW4932



JPW4933

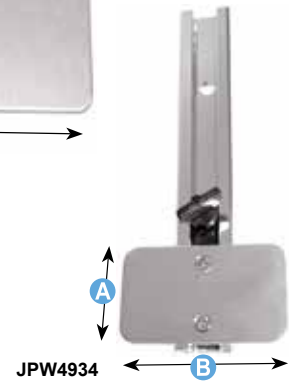

JPW4934

Part No.	Plate Type	Dimensions (mm)		
		A	B	C
JPW4932	Large Flat	93	152	-
JPW4933	Right Angled	112	90	65
JPW4934	Small Flat	50	85	-

### Stainless Steel Davit - Pair

Polished 316-grade stainless steel lightweight davit with recessed deck mounts. Sold as a pair with lifting tackle included.

- Removable arms to provide more space on deck and transom.
- Ideal for lifting outboard motors, sea bags, scuba gear etc.
- Can be used on sailboats or powerboats.
- Weatherproof and corrosion resistant.
- Removable arms swivel around 360°
- Lifting capacity per pair: 100kg or 160kg.
- Overall L x H: 800 x 1050mm.

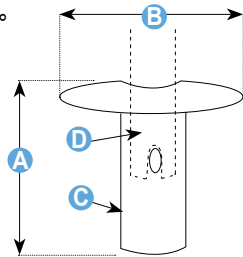

Removable Base



#### Kit includes:

- 2 x Davit Arms (Height: 1050mm) with removable bases and under deck base plates
- 2 x 8mm snap hooks
- 2 x 6mm 'D' shackles
- 2 x 40mm pulleys
- 2 x 8mm nylon ropes (Length: 2.5m)

\*Mounting bolts not supplied.

Part No.	Capacity (kg)	Base Dimensions (mm)			
		A	B	C	D
JPW6174	100	120	130	45	40
JPW6175	160	130	145	54	50



### StopGull Air Seagull Deterrent

The StopGull Air prevents the landing of seagulls and coastal birds on boats, boat's hardtops, inflatables, sailboats and professional vessels. The flags housed at the end of the bar start to rotate when wind hits them, deterring birds from perching on the boat.

- Easy to install, arms fold upwards and can removed from the base for stowing.
- Can be applied to any part of your boat using additional supports (sold separately).



Overall length includes flags

Part No.	Length (m)
JPW10310	1.85
JPW10311	2.35

JPW10340 Replacement Base Mount

### StopGull Air Handrail Support

This StopGull Air Support can be attached to 22 - 38mm diameter handrails and is made of anodised aluminium.

- Install in a vertical or horizontal position.
- Quick and easy to install.



Part No.	Height (mm)	Length (mm)	Width (mm)
JPW10315	130	70	16

### StopGull Air Boom and Folded Bimini Support

This StopGull support allows you to install the StopGull Air device at any kind of bimini when they are folded or aluminium booms when the sails are lowered.

- Includes long textile straps with safety fasteners.



Part No.	Straps Length (m)
JPW10319	1

### StopGull Air Large Rail Mount Support 38mm To 110mm

The StopGull Air Large Rail Support mount can be attached to rails from 38mm - 110mm diameter. Simply place the support on top of the rail, and pull the elastic cord tight around the rail, securing with the eyelets.



Part No.	Height (mm)	Length (mm)	Width (mm)
JPW10328	40	160	240

### StopGull Air Open Bimini Support

For mounting the StopGull Air onto an open bimini and is adaptable for tubes from 22 to 38mm. Made from 316-grade stainless steel.

- Can be folded with the bimini arch support installed.



Part No.	Height (mm)	Length (mm)	Width (mm)
JPW10316	60	60	40

### StopGull Air Suction Cup Support

The Suction Cup Support is suitable for installation of the StopGull Air device at hatches, outboard motors, etc. Includes the base to fit the StopGull Air easily.

Part No.	Height (mm)	Length (mm)	Width (mm)
JPW10317	100	70	70



### StopGull Air RIB Support Kit

This StopGull Support will fit the StopGull Air device to all kinds of inflatable boats. Made from a nautical acrylic fabric with flexible ropes and four hooks to fix at the external profile of the inflatable boat. It also includes a telescopic mast for its final tightening.



Part No.
JPW10320

### StopGull Air Keeper

Designed to be installed on the radar, TV antenna, lamp posts, marine installations, etc. where gulls and shorebirds use as a lookout point.

- Deters birds by the disposal of its rods and their movement by the wind.
- Installation requires an industrial adhesive.



Part No.	Diameter (mm)	Height (mm)
JPW10326	500	310

### StopGull Air Boat Vent 3 Support

The StopGull Air can be installed on the mooring canvas through the Boat Vent 3 device to provide two great benefits. It prevents seagulls and coastal birds from landing on the mooring canvas and at the same time allows the inside of the boat to aerate to prevent moisture, mildew and bad smell.



Part No.	Diameter (mm)	Height (mm)
JPW10322	120	50

### StopGull Air S27 Transparent

The swivel piece StopGull S27 is designed for installing on critical points on your boat to deter gulls and shorebirds. Prevents birds landing on the mast spreaders, top of mast, nav lights, etc.

- Includes a double sided adhesive for installation.
- Can be installed at port signals.



Part No.	Diameter (mm)	Height (mm)
JPW10327	50	55

### StopGull Air Boat Vent Telescopic Support Pole



Part No.	Length (mm)
JPW10324	850 - 1500
JPW10325	950 - 1800

### StopGull Air Replacement Base Mount

Replacement Base Mount for StopGull Air.



Part No.
JPW10340

### StopGull Air Sandbag Support

The StopGull Sandbag Support is suitable for installing the StopGull Air device on rough surfaces as well as deck mats.

- Sand not included.



Part No.	Size (mm)
JPW10321	350 x 350

### Scanstrut PowerTower Aluminium 150mm



Designed and engineered to install a radar on the roof, T-top, fly-bridge or radar arch of a powerboat. Pre-drilled mounting holes allow the radar to fasten straight to the PowerTower top plate with the radar's own mounting bolts.

- Made from marine grade aluminium.
- Watertight installation - marine sealant not required.
- Hollow stem for internal cable routing through the center.
- Top plate with center hole and internally mounted cable seal.



Part No.	Colour	Dimensions L x W x H (mm)
JPW10450	White	280 x 190 x 150
JPW10451	Black	280 x 190 x 150



### Scanstrut PowerTower for Starlink Flat High Performance 150mm



Install Starlink with precision on the roof, T-top, flybridge, or radar arch. It guarantees obstacle clearance and positions the Starlink at an ideal 8° angle for optimal connectivity.

- Constructed from marine-grade aluminium.
- Scanstrut Cable Seal ensures watertight installation.
- Pre-drilled mounting holes.



Part No.	Type	L x W x H (mm)
JPW10468	PowerTower	426 x 340 x 238
JPW10469	8deg Wedge	426 x 340 x 94



### Scanstrut Composite PowerTower



These single "monocoque" structures with no joints, have outstanding strength and the aerodynamic shape and high gloss finish makes a product that is as strong as it is attractive.

- Hollow stem for internal cable routing through the center.
- Watertight installation - marine sealant not required.
- Made from white composite materials.
- Aesthetic single piece moulding.
- Solid top plate.



Part No.	Dimensions L x W x H (mm)
JPW10463	268 x 275 x 150



### Scanstrut Modular Dual PowerTowers



Specifically designed for mounting the most up to date radars with Satcom, camera or nav lights.

- Small mounting footprint, saves space on roof or flybridge.
- Pre-drilled mounting holes.



Part No.	Type	L x W x H (mm)
JPW10534	Open Array	1076 x 291 x 584
JPW10535	Standard	698 x 291 x 525
JPW10536	Compact	671 x 291 x 325



### Scanstrut PowerTower Base Wedge 4deg



Angles the radar down 4° below horizontal to provide a level horizon for the radar when the boat is underway.

- Tough, marine-grade and UV stable.
- Fits the Composite and Aluminium PowerTowers above.



Part No.	Dimensions L x W x H (mm)
JPW10465	200 x 200 x 20



### Scanstrut PowerTower Central Light Bar Mount



Central light bar for mounting a range of navigation lights onto the Scanstrut PowerTowers with internal cable routing.

- Max weight: 1kg.
- Length x Height: 262 x 404mm.



Part No.	Colour
JPW10450	White
JPW10451	Black



### Scanstrut PowerTower Radome Plates



Plates designed to install radomes to the Modular Dual PowerTowers.



JPW10551



JPW10552



Part No.	Type	L x W x H (mm)
JPW10551	Garmin / Raymarine	268 x 170 x 6
JPW10552	Furuno	203 x 203 x 6

### Scanstrut Flagship Tapered Radar Mount



A single combination mount made from marine grade aluminium, for radar, lights, GPS/VHF antennas, cameras or search lights.

- Compatible with all current 18" and 24" radomes.
- Hollow wings and stem allow hidden cabling.
- Pre-drilled mounting holes
- Un-drilled top plate to fit any light.
- Install up to 4 GPS/VHF antennas.



Accessories not included



Part No.	Type	L x W x H (mm)
JPW10466	Garmin / Raymarine	935 x 806 x 729
JPW10467	Furuno	935 x 806 x 729

### Scanstrut Radar Mast Mounts



Made from marine-grade aluminium, these radar mounts attach to mast with four swivel feet, matching a variety of mast profiles.

- Universal strong fixing mounting with pre-drilled holes.
- Minimum mast width: 65mm.
- 12 point fixing using high-quality Monel rivets.
- Includes Safety Wire kit.



Part No.	Colour	Length (mm)	Width (mm)
JPW10491	Black	395	263
JPW10492	White	395	263
JPW10461	White	484	263

### Scanstrut Self-Levelling Radar Backstay Mount 2.6m



With hydraulic damping, it mounts forward of the backstay, keeping the radar away from any interference. Bespoke mounting pole (2.6m) supplied in 2 lengths with hidden joiner piece.

- Fine tuned adjustable stainless radome cradle.
- Clamps around backstay allow cable tension adjustment.
- Cables are hidden within a cable channel.



Part No.
JPW10456



### Scanstrut Starlink High-Performance Flagship Radar Mount



A single combination mount made from marine grade aluminium, for radar, lights, GPS/VHF antennas, cameras or search lights.

- Designed to fit Starlink's Flat High-Performance Model.
- Hollow wings and stem allow hidden cabling.
- Pre-drilled mounting holes.



Part No.	Type	L x W x H (mm)
JPW10466	Garmin / Raymarine	1095 x 820 x 808
JPW10467	Furuno	1095 x 820 x 808



# HOW TO ORDER

Select products from the catalogue or through our website using the product categories or search function. Make note of the part numbers to facilitate ordering.

## ONLINE



Login to our website  
with your customer username & password.

[www.jpwmarine.com.au](http://www.jpwmarine.com.au)

If you know our product codes, use the  
'Quick Order' form for a speedy checkout.

## PHONE



Call us during standard  
Western Australian business hours on

**(08) 6253 3000**

to place order by phone.

## EMAIL

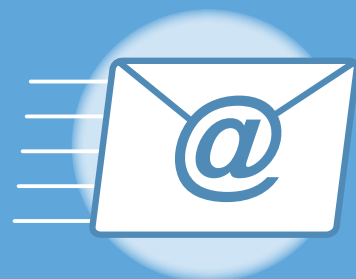

Email your order to

[orders@jpwmarine.com.au](mailto:orders@jpwmarine.com.au)



# JPW MARINE

WHOLESALE MARINE SPECIALISTS